

## SMART X72-5G

*Smart Power Analyzer for Single and Three Phase System*



- Measures kWh, kVArh, KW, kVA, PF, Hz, dmd, V, A, etc.
- Bi-directional measurements
- Up to 15<sup>th</sup> THD and IHD
- 4 Digital Input & 2 Digital Output
- Support 3p4w, 3p3w, 2p3w, 1p2w system
- CT and PT operated
- RS485 Modbus communication
- Real time power factor histogram
- Accuracy Class 0.5s

### ***User Manual V3.6***

## Application

SMART X72-5G is a top new-generation intelligent multifunction panel meter, used not only in the electricity transmission and power distribution system but also in the power consumption measurement and analysis in low and medium voltage intelligent power grid.

This document provides operating, maintenance and installation instructions for the Eastron SMART X72-5G. The unit measures and displays the characteristics of single phase two wire, two phase three wire, three phase three wire and three phase four wire supplies. Including voltage, frequency, current, power, active and reactive energy, imported or exported energy, harmonic, power factor, Max. demand etc. Energy is measured in terms of kWh, kVAh. Maximum demand current can be measured over preset periods of up to 60minutes. The requisite current input(s) are obtained via current transformers.

The SMART X72-5G can be configured to work with a wide range of CTs, giving the unit a wide range of operation. Built-in interfaces provide digital input, digital output and RS485 Modbus RTU outputs.

## PART 1 Specification

### Input

Norminal input voltage	50-276V AC(L-N)	87-480V AC(L-L)
Max.short duration input voltage	2x nominal voltage for 0.5 second	
Nominal input voltage burden	< 0.2VA per phase	
Nominal input current	1A/ 5A	
Nom. input current burden	< 0.1VA	
Max. continuous input overload current	120% of nominal	
Max. short duration input current	20x nominal current for 0.5 second	
Starting current	0.08% Ib	

### Auxiliary Power Supply

Operating range	65-276V AC/ 90-380V DC
Supply burden	<2W/ 10VA

### Measured Range

Voltage(V)	50-276V AC(L-N)      87-480V AC(L-L)
Current(A)	5-120% of nominal
Frequency(Hz)	45- 66 Hz
Power(W, VAr, VA)	5-120% of nominal (bi-directional)
Energy	8 digits, up to 9999999.9kWh
Power factor	4 quadrants
THD	0-40% up to 15 <sup>th</sup> harmonic

### Accuracy

Voltage(V)	0.5% of range maximum
Current(A)	0.5% of range maximum
Frequency(Hz)	0.2% of mid-frequency
Power factor(PF)	1% of unity
Active power(W)	1% of range maximum
Reactive power(VAr)	1% of range maximum
Apparent power(VA)	1% of range maximum
Active energy(kWh)	Class 0.5s IEC62053-22
Reactive energy(KVArh)	Class 2 IEC62053-23
THD	2% to 15 <sup>th</sup> harmonic

### Environment

Operating temperature	-25℃ to +55℃
Storage and transportation temperature	-40℃ to +70℃
Relative humidity	0 to 95%, non-condensing
Altitude	up to 2000m
Warm up time	3s
Installation category	CAT III
Mechanical environment	M1
Electromagnetic environment	E2
Ingress protection	IP51(Indoor)
Degree of pollution	2

**Output**

**RS485 output for Modbus RTU**

The meter provides a RS485 port for remote communication. Modbus RTU is the protocol applied. For Modbus RTU, the following RS485 communication parameters can be configured by the Modbus command.

**Baud rate:** 2400, 4800, 9600, 19200, 38400 bps. Default: 9600 bps

**Parity:** NONE/ EVEN/ ODD

**Stop bits:** 1 or 2

**Modbus address:** 1 to 247

## PART 2 Operation

**Start-up Screens**

	<p>The first screen lights all display segments and can be used as a display check.</p>
	<p>The second screen indicates the firmware installed in the unit and its build number.</p>
	<p>Next the unit performs a self-test and indicates if the test passes.</p>

Measurements

The buttons operate as follows

	Shot press <ul style="list-style-type: none"> <li>● Display voltage, current, THD of voltage and current information</li> <li>● Phase sequence</li> <li>● Exit from the menu</li> </ul>
	Long Press <ul style="list-style-type: none"> <li>● Automatic scroll display ON/OFF</li> </ul>
	Shot press <ul style="list-style-type: none"> <li>● Display power factor, frequency, Max.demand</li> <li>● Up page or add value</li> </ul>
	Long Press <ul style="list-style-type: none"> <li>● Individual harmonic distortion of voltage up to 15th</li> </ul>
	Shot press <ul style="list-style-type: none"> <li>● Display active power, reactice power and apparent power information</li> <li>● Down page or reduce value</li> </ul>
	Long Press <ul style="list-style-type: none"> <li>● Individual harmonic distortion of current up to 15th</li> </ul>
	Shot press <ul style="list-style-type: none"> <li>● Display total/ import/ export active or reactive energy information</li> <li>● Right side move</li> </ul>
	Long Press <ul style="list-style-type: none"> <li>● Set-up mode entry</li> <li>● Confirmation</li> </ul>

Click button	Screen	Parameters
	1	Phase to neutral voltages
	2	Phase to phase voltages
	3	Current on each phase
	4	Neutral current
	5	Voltage THD% of each phase
	6	Current THD% of each phase
	1	Total power factor Frequency
	2	Power factor of each phase
	3	Max.current demand of each phase
	4	Max.power demand of W Max.power demand of VAR Max.power demand of VA

	1	Active power(kW) of each phase
	2	Reactive power(kVAr) of each phase
	3	Apperant power(kVA) of each phase
	4	Total kW, kVAr, kVA
	1	Total active energy(kWh)
	2	Total reactice energy(kVArh)
	3	Imported active energy(kWh)
	4	Exported active energy(kWh)
	5	Imported reactive energy(kVArh)
	6	Exported reactive energy(kVArh)

	<p>Press button  for 2 seconds to turn on/ off automatic scroll display.</p>
	<p>Press  for 2 seconds to check harmonic distortion of voltage 2~15<sup>th</sup>.</p>
	<p>Press  for 2 seconds to check harmonic distortion of current 2~15<sup>th</sup>.</p>

Set Up

Long press button  to enter the set-up interface.



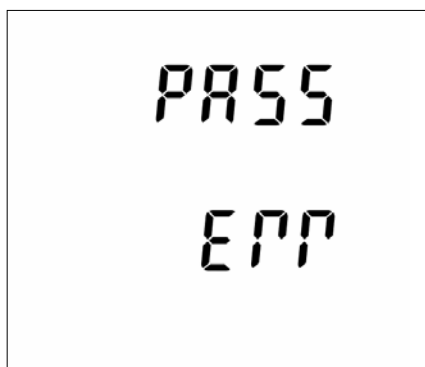

The default password is 1000. If the input is wrong, the LCD displays “PASS Err”.



Press the button  to exit set-up interface.

Set-up Mode

1. Communication

	Long press  to enter the communication setting menu.
---	---

### 1.1 Modbus address

	<p>The default address is 001. Long press  to activate the modification.</p>
	<p>Use  and  buttons to set the address with the range 001~247, and long press the button  for confirmation.</p>
<p>Long press  to confirm the setting and press  to return to the main set-up menu.</p>	

### 1.2 Baud rate

	<p>From the set-up menu, use  and  buttons to select the baud rate option. The default is 9600bps.</p>
	<p>Long press  to enter the selection routine. The baud rate setting will flash. Use  and  buttons to choose baud rate 2.4k, 4.8k, 9.6k, 19.2k, 38.4k.</p>
<p>Long press  to confirm the setting and press  to return to the main set-up menu.</p>	









### 1.3 Parity

	<p>From the set-up menu, use  and  buttons to select the parity option(ODD/ EVEN/ NONE). Default is NONE.</p>
	<p>Long press  to enter the selection routine. The current setting will flash. Use  and  buttons to choose parity (EVEN/ ODD/ NONE).</p>
<p>Long press  to confirm the setting and press  to return to the main set-up menu.</p>	



### 1.4 Stop bits

	<p>From the set-up menu, use  and  buttons to select the stop bit option (1/ 2). Default it 1.</p>
	<p>Long press  to enter the selection routine. The current setting will flash. Use  and  buttons to choose stop bit (1/ 2). <b>Please note stop bits can only be set 2 when parity is NONE.</b></p>
<p>Long press  to confirm the setting and press  to return to the main set-up menu.</p>	

### 2. CT

<p style="text-align: center;">SEt</p> <p style="text-align: center;">Ct</p>	<p>From the set-up menu, use  and  buttons to select the CT option.</p>
<p style="text-align: center;">SEt</p> <p style="text-align: center;">Ct2</p> <p style="text-align: center;">5 A</p>	<p>Long press  to enter the CT secondary current selection routine (5A/ 1A).</p>
<p style="text-align: center;">SEt</p> <p style="text-align: center;">Ct1</p> <p style="text-align: center;">0005 A</p>	<p>Long press  to enter the CT primary set-up interface. The range is from 0005~9999. Default is 0005.</p>
<p>Long press  to confirm the setting and press  to return to the main set-up menu.</p>	

### 3. PT

<p style="text-align: center;">SEt</p> <p style="text-align: center;">Pt</p>	<p>From the set-up menu, use  and  buttons to select the PT option.</p>
--	---

	<p>Long press  to enter the PT secondary current selection routine.</p> <p>Press  and  buttons to choose PT2. The range is from 30~500. Default is 230V.</p>
	<p>Long press  to enter the PT primary selection routine.</p> <p>Press  and  buttons to choose PT1. The range is from 0030~500000. Default is 0230V.</p>
<p>Long press  to confirm the setting and press  to return to the main set-up menu.</p>	

#### 4. Demand

	<p>From the set-up menu, use  and  buttons to select the demand options.</p>
--	--

#### 4.1 Demand method

	<p>From the set-up menu, use  and  buttons to select the demand calculation method. Options: Fix and Slid</p>
--	---

	<p>Long press  to enter the selection routine. The setting will flash.</p> <p>Use  and  buttons to choose options.</p>
<p>Long press  to confirm the setting and press  to return to the main set-up menu.</p>	

#### 4.2 DIT(Demand integration time)

This sets the period in minutes over which the current and power readings are integrated for maximum demand measurement. The options are: 0(off), 5, 8, 10, 15, 20, 30, 60 minutes

	<p>From the set-up menu, use  and  buttons to select the dit option. The screen will show the currently selected integration time. Default is 60 minutes.</p>
	<p>Long press  to enter the selection routine. The current time interval will flash.</p> <p>Use  and  buttons to select the time required.</p>
<p>Long press  to confirm the setting and press  to return to the main set-up menu.</p>	

### 4.3 Sliding time

	<p>Long press  to enter the selection routine. The current sliding time will flash.</p> <p>Use  and  buttons to select sliding time. Range: 1-59. The sliding time shall be set not longer than the DIT.</p>
--	--

## 5. Time

	<p>From the set-up menu, use  and  buttons to select the time options.</p>
--	--

### 5.1 Backlit time

The meter provides a function to set the white backlit lasting time.

	<p>The backlit lasting time is settable. Default lasting time is 60minutes. For example, if it's set as 5, the backlit will be off in 5minutes. Notes: If it's set as 0, the backlit will always be on.</p>
--	---

	<p>Long press  to enter the selection routine. The current time interval will flash.</p> <p>The options can be: 0/ 5/ 10/ 30/ 60/ 120minutes</p>
<p>Long press  to confirm the setting and press  to return to the main set-up menu.</p>	

### 5.2 Display scroll time

	<p>From the set-up menu, use  and  buttons to select page.</p> <p>Long press the button  to activate the modification on the time.</p> <p>Use the  and  to choose options.</p> <p>Options: 001-255 seconds Default is 5 seconds.</p>
<p>Long press  to confirm the setting and press  to return to the main set-up menu.</p>	

### 6. Supply system

Use this section to set the type of power supply being monitored.

	<p>From the set-up menu, use  and  buttons to select the system option. The screen will show the currently selected power supply.</p>
--	---

<p>SEt</p> <p>545</p>	<p>Long press  to enter the selection routine. The current selection will flash.</p> <p>Use  and  buttons to select the required system option: 3P4W, 3P3W or 1P2W.</p>
<p>Long press  to confirm the setting and press  to return to the main set-up menu.</p>	

### 7. System Connection

<p>SEt</p> <p>545</p> <p>cnct</p>	<p>This units support reverse connected current inputs correction setting.</p> <p>From the set-up menu, use  and  buttons to select system connection page.</p> <p>Options: Frd (forward) and Rev (reverse)</p> <p>The default is Frd (forward)</p>
<p>SEt</p> <p>1A</p> <p>Frd</p>	<p>Long press  to enter Phase A.</p> <p>Long press  , the setting will flash. Use  and  to choose options.</p>
<p>SEt</p> <p>1b</p> <p>Frd</p>	<p>Long press  to enter Phase B.</p> <p>Long press  , the setting will flash. Use  and  to choose options.</p>

	<p>Long press  to enter Phase C.</p> <p>Long press , the setting will flash. Use  and  to choose options.</p>
<p>Long press  to confirm the setting and press  to return to the main set-up menu.</p>	

**8. Change password**

	<p>Use the  and  to choose the change password option.</p> <p>Default: 1000 Options: 0000~9999</p>
	<p>Long press  the setting will flash.</p> <p>Use  and  to choose options.</p>
<p>Long press  to confirm the setting and press  to return to the main set-up menu.</p>	

**9. Digital input(DI)**









	<p>From the set-up menu, use  and  buttons to select digital input page.</p> <p>Long press  to enter the sub-menu.</p>
--	--



	<p>This is to set filtering time for a digital input signal. Options: 0~255s</p>
	<p>This screen is to check the counting number of each digital inputs. Long press  to check counting numbers.</p>
	<p>Press  and  to check counting number of different digital inputs.</p>
<p>Long press  to confirm the setting and press  to return to the main set-up menu.</p>	

**10. Digital output(DO)**

	<p>From the set-up menu, use  and  buttons to select digital output page. Long press  to enter the sub-menu.</p>
--	--

<p>SET</p> <p>DO-1</p>	<p>Press  and  to choose different digital output.</p> <p>Long press  to set the parameters and check the status of DO-1.</p>
<p>SET</p> <p>DO-1</p> <p>AL</p>	<p>Long press  to set the alarm information.</p> <p>For details, please refer to part 11.</p>
<p>DO-1</p> <p>TYPE</p> <p>PULS</p>	<p>Use  and  to choose digital output type.</p> <p>This option is level and pulse.</p>
<p>DO-1</p> <p>WIDTH</p> <p>1000</p>	<p>Use  and  to set the output width of DO-1.</p> <p>Options: 50~3000ms.</p>

	<p>Use  and  to set the status of DO-1 relay.</p>
<p>Long press  to confirm the setting and press  to return to the main set-up menu.</p>	

















### 11. Alarm setting of DO

	<p>From the set-up menu, use  and  buttons to select alarm setting of DO page.</p> <p>Long press  to enter the sub-menu.</p>
	<p>Use  and  to choose options.</p> <p>The alarm objects can be: Null, U1, U2, U3, Unav(L-N), U12, U23, U31, Uuav(L-L), Q1, Q2, Q3, Q-total, S1, S2, S3, S-total, PF1, PF2, PF3, PF-total, F(frequency).</p> <p>Null means there is no alarm object.</p>
	<p>Use  and  to set the DO action delay time.</p> <p>The unit is ms.</p>

<p>The LCD display shows the menu 'SET d0-1 HC' with the value '1000' in red. A small 'V' is visible to the right of the 'HC' text.</p>	<p>Use  and  to set the high value to close the DO-1. Left picture shows HC(high value to close) 1000V, that means when the U1 reaches to 1000V, the DO-1 will close.</p>
<p>The LCD display shows the menu 'SET d0-1 HO' with the value '800' in red. A small 'V' is visible to the right of the 'HO' text.</p>	<p>Use  and  to set the high value to open the DO-1. Left picture shows HO(high value to open) 800V, that means when the U1 reaches to 800V, the DO-1 will open.</p>
<p>The LCD display shows the menu 'SET d0-1 LC' with the value '100' in red. A small 'V' is visible to the right of the 'LC' text.</p>	<p>Use  and  to set the low value to close the DO-1. Left picture shows LC(low value to close) 100V, that means when the U1 drops to 100V, the DO-1 will close.</p>
<p>The LCD display shows the menu 'SET d0-1 LO' with the value '170' in red. A small 'V' is visible to the right of the 'LO' text.</p>	<p>Use  and  to set the low value to open the DO-1. Left picture shows LO(low value to open) 170V, that means when the U1 drops to 170V, the DO-1 will open.</p>
<p>Long press  to confirm the setting and press  to return to the main set-up menu.</p>	

12. Reset

	<p>From the set-up menu, use  and  buttons to select reset page.</p>
	<p>Use  and  to choose options. This option is to reset active energy.</p> <p>Long press  the setting will flash. Long press  again to confirm.</p>
	<p>Use  and  to choose options. This option is to reset reactive energy.</p> <p>Long press  the setting will flash. Long press  again to confirm.</p>
	<p>Use  and  to choose options. This option is to reset demand.</p> <p>Long press  the setting will flash. Long press  again to confirm.</p>

	<p>Use  and  to choose options. This option is to reset Max value.</p> <p>Long press  the setting will flash. Long press  again to confirm.</p>
	<p>Use  and  to choose options. This option is to reset digital input information.</p> <p>Long press  the setting will flash. Long press  again to confirm.</p>
	<p>Use  and  to choose options. This option is to reset all information.</p> <p>Long press  the setting will flash. Long press  again to confirm.</p>
<p>Long press  to confirm the setting and press  to return to the main set-up menu.</p>	

Dimensions

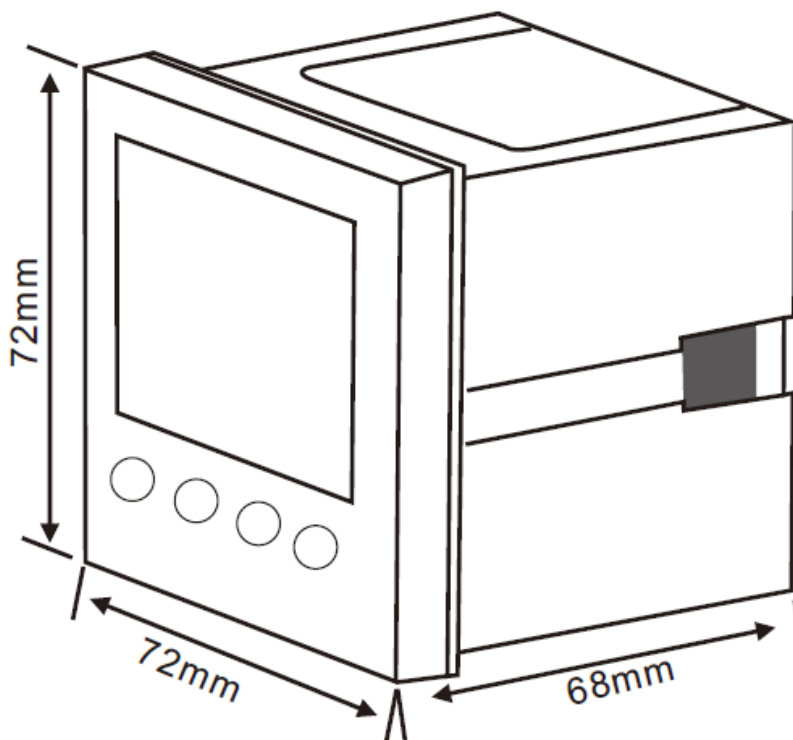

Wiring Diagram

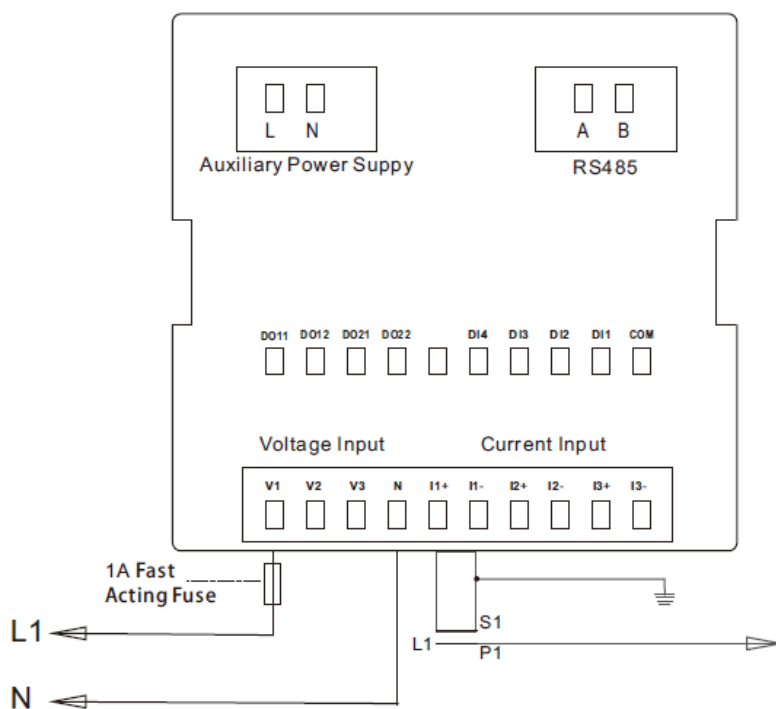

**1-Phase 2-Wire**

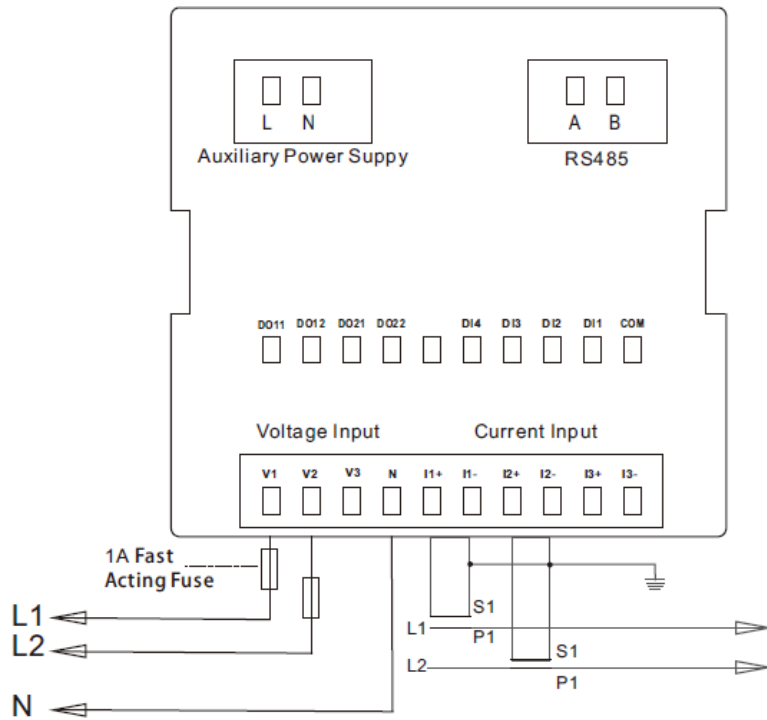

**2-Phase 3-Wire**

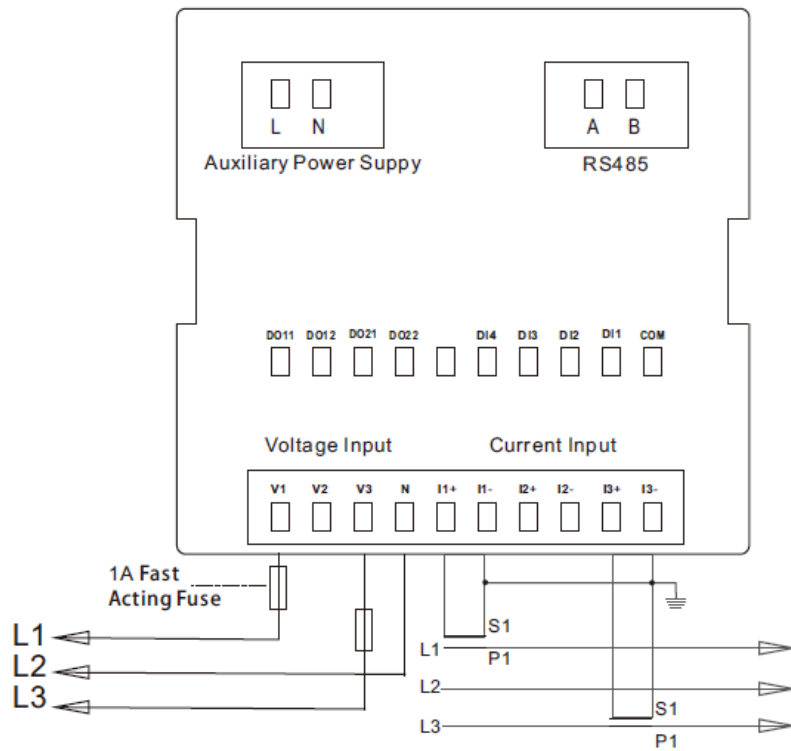

**3-Phase 3-Wire**



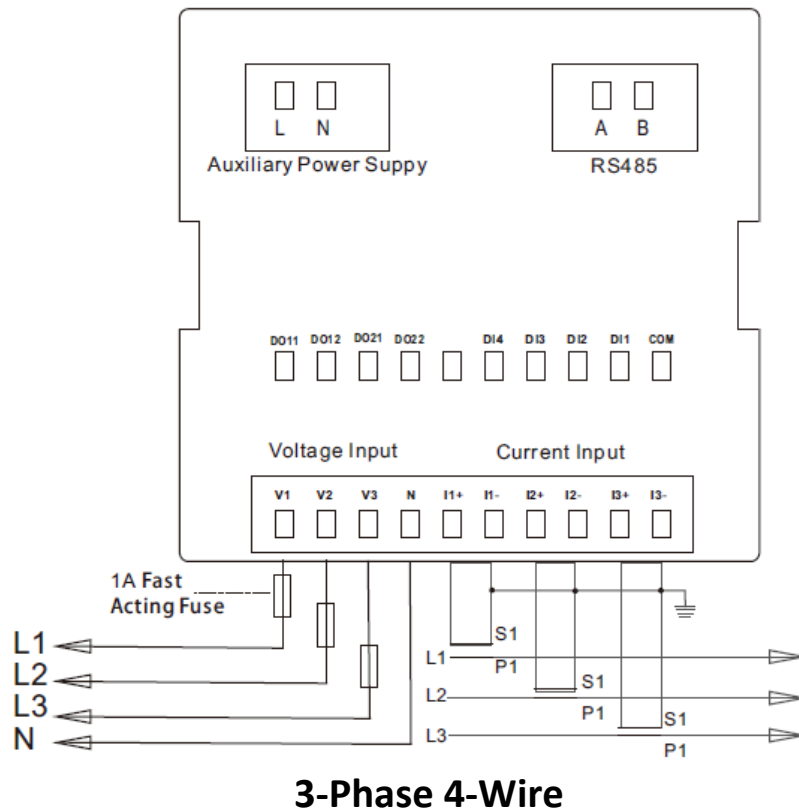

IF you have any question, please feel free to contact our sales team.

**Zhejiang Eastron Electronic Co., Ltd.**

No.1369, Chengnan Rd. Jiaxing, Zhejiang, 314001, China

Tel: +86-573-83698881 Fax: +86-573-83698883

Email: sales@eastrongroup.com

[www.eastrongroup.com](http://www.eastrongroup.com)