

## SDM18-M

### Single-Phase Multifunction DIN Rail Meter



- Measures kWh, kVAh, kW, kVA, PF, Hz, dmd, V, A, etc.
- Bi-directional measurement IMP & EXP
- RS485 Modbus RTU
- Din rail 35mm
- 100A direct connection
- Better than Class 1 accuracy

### User Manual V1.0

## Application

The energy-meters are used to measure single-phase applications like residential, utility and Industrial. The unit measures and displays various important electrical parameters. It equipped with a white back-lighted LCD screen for prefect reading. As well as a RS485 communication port for remote reading and monitoring. Bi-directional energy measurement makes it a good choice for solar PV energy metering. The compact design and din rail installation provides an easy and economical solution for your metering demand.

# PART 1 Specification

## General Specifications

Voltage AC (Un)	230V
Voltage Range	176~276V AC
Base Current (Ib)	10A
Max. Current (Imax)	100A
Mini Current (Imin)	0.5A
Starting current	0.4% of Ib
Power consumption	<2W/10VA
Frequency	50/60Hz(±10%)
AC voltage withstand	4KV for 1 minute
Impulse voltage withstand	6KV-1.2uS waveform
Overcurrent withstand	30Imax for 0.01s
Pulse LED	1000imp/kWh
Display	LCD with white backlit
Max. Reading	99999.9kWh

## Accuracy

Voltage	0.5% of range maximum
Current	0.5% of nominal
Frequency	0.2% of mid-frequency
Power factor	1% of Unity
Active power	1% of range maximum
Reactive power	1% of range maximum
Apparent power	1% of range maximum
Active energy	Class 1 IEC62053-21 Class B EN50470-1/3
Reactive energy	Class 2 IEC62053-23

## Environment

Operating temperature	-40°C to +70°C
Storage and transportation temperature	-40°C to +70°C
Reference temperature	23°C ± 2°C
Relative humidity	0 to 95%, non-condensing
Altitude	up to 2000m
Warm up time	3s
Installation category	CAT III
Mechanical Environment	M1
Electromagnetic environment	E2
Degree of pollution	2

## Output

### RS485 output for Modbus RTU

The meter provides a RS485 port for remote communication. Modbus RTU is the protocol applied. For Modbus RTU, the following RS485 communication parameters can be configured from the set-up menu.

**Baud rate:** 1200, 2400, 4800, 9600 bps. Default: 9600bps

**Parity:** NONE/EVEN/ODD. Default: NONE

**Stop bits:** 1 or 2

**Modbus Address:** 1 to 247 (default 1)



## Mechanics

Din rail dimensions	18x90x66mm (WxHxD) DIN 43880
Mounting	DIN rail 35mm
Ingress protection	IP51 (indoor)
Material	Self-extinguishing UL94V-0

## PART 2 Operation

### Initialization Display

When it is powered on, the meter will initialize and do self-checking.

1		Full Screen It will last for 3 seconds.
2		Software version in kind prevail It will last for 3 seconds.



After the self-checking program, the meter display will show total active energy (kWh)





### Scroll Display by Button



There is a button on the front panel of the meter.

After initialization and self-checking program, the meter display the measured values. The default page is total kWh. If the user wants to check other information, he needs to press the scroll button on the front panel.

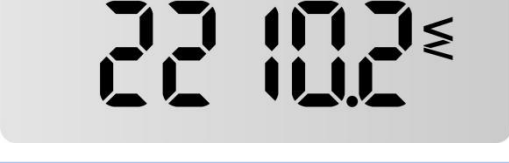
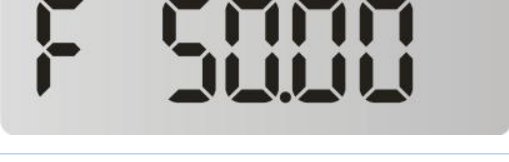
	Press the button, the LCD display will scroll the measurements.  Keep pressing the button for 3 seconds, the meter will enter into set-up mode.
---	---

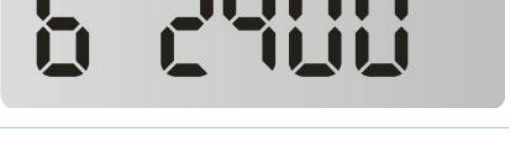
1		Total active energy (kWh) Display format: 0000.00→9999.99→10000.0→99999.9→0000.00
2		Import active energy (kWh) Display format: 0000.00→9999.99→10000.0→99999.9→0000.00

3		Export active energy (kwh) Display format: 0000.00→9999.99→10000.0→ 99999.9→0000.00
4		Voltage (V)
5		Current (A)
6		Active power (W)
7		Frequency ( F )
8		Power factor ( PF)
9		Modbus address ( ID) Default: 001
10		Baud rate Default : 9600bps

11		Parity None/even/odd are optional Default: none
12		Software version in kind prevail







### Set-up Mode

To get into Set-up Mode, the user need keep pressing the button for 3 seconds, the meter will enter into the set-up mode.



The meter support to set three parameters : Address, Baud Rate, and Parity.

Notice: Under the “SET” mode, If there is no operation, the display will back to the default display.

### Modbus Address setting

	Under this menu, long press the button  for 3 seconds enter to the set up mode.
	The rightmost digit will flash, press the button  to increase or decrease number, and then waiting for 4 seconds, the middle digit will flash, press the button  again to choose the correct number, and waiting 4 seconds until the last digit flash, repeat above options until all the digits are set.
	After the setting of final digit, waiting for 4 seconds, the address information will be stored automatically. Short press the button to enter into the next setting page. If long time no operation, the display will return to the default display.

### Baud rate setting

	Under this menu, long press the button  for 3 seconds enter to the set-up mode.
---	--

	The digits will flash, press the button  to choose baud rate options (from 1200 to 9600 bps), then waiting for 4 seconds
	the baud rate setting will be stored automatically after 4 seconds. Short press the button  to enter into the next setting page. If long time no operation, the display will return to the default display.

**Parity setting**

	Under this menu, long press the button  for 3 seconds enter to the set-up mode.
	The digits will flash, press the button  to choose parity options (None/Even/Odd), then waiting for 4 seconds Notice: n=None, e=Even, o= Odd
	the parity setting will be stored automatically after 4 seconds and the screen will return to the setting display.

The user can program the meter parameters by sending correct command via RS485 port. The protocol is Modbus RTU. For the details. Please look at the "Eastron SDM18-M Modbus protocol".

**Wiring Diagram**

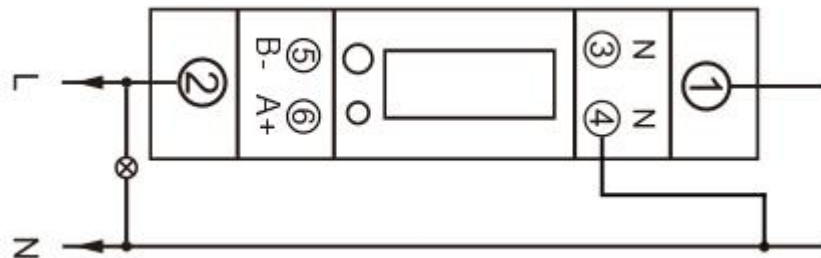

- Port 1 / 2: L-in/ L-out
- Port 3 / 4: N
- Port 5 / 6: RS485 B- / RS485 A+

Terminals		
RS485 / N	0.5~1.5mm <sup>2</sup>	0.2Nm
L in / L out	2.5~10mm <sup>2</sup>	1.5Nm

### Dimensions

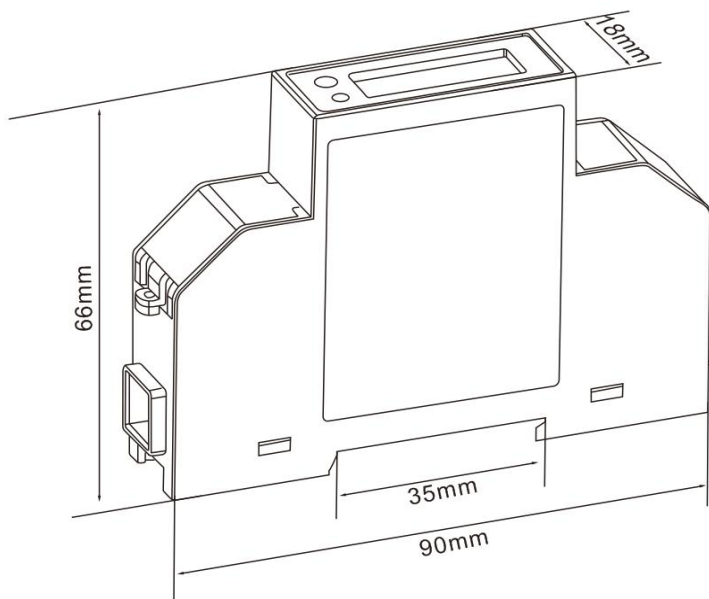

### Installation

35mm

DIN Rail



## Modbus register Map

### Eastron SDM18-M Modbus protocol

Function code	
04	to read input parameters

Address (Register)	Input Register Parameter			Modbus Protocol Start Address Hex	
	Parameters	Unit	Format	Hi byte	Low Byte
30001	Voltage	Volts	Float	00	00
30007	Current	Amps	Float	00	06
30013	Active power	Watts	Float	00	0C
30019	Apparent power	VA	Float	00	12
30025	Reactive power	VAr	Float	00	18
30031	Power factor	None	Float	00	1E
30071	Frequency	Hz	Float	00	46
30073	Import active energy	kWh	Float	00	48
30075	Export active energy	kWh	Float	00	4A
30077	Import reactive energy	kVArh	Float	00	4C
30079	Export reactive energy	kVArh	Float	00	4E
30085	Total system power demand	W	Float	00	54
30087	Maximum total system power demand	W	Float	00	56
30089	Import system power demand	W	Float	00	58
30091	Maximum Import system power demand	W	Float	00	5A
30093	Export system power demand	W	Float	00	5C
30095	Maximum Export system power demand	W	Float	00	5E
30259	current demand.	Amps	Float	01	02
30265	Maximum current demand.	Amps	Float	01	08
30343	Total active energy	kWh	Float	01	56
30345	Total reactive energy	kVArh	Float	01	58

Function code	
10	to set holding parameter
03	to read holding parameter

Address Register	Holding Register Parameter		Modbus Protocol Start Address Hex		Description
	Parameters	Format	Hi byte	Low byte	
40003	Demand Period	Float	00	02	Write demand period: : 0, 5,8, 10, 15, 20, 30, 60 minutes, default 60. Setting the period to 0 will cause the demand to show the current parameter value, and demand max to show the maximum parameter value since last demand reset.
40013	Pulse 1 Width	Float	00	0C	Write Pulse 1 Width in milliseconds: 60, 100 or 200, default 60ms. <b>Length : 4 byte</b> <b>Data Format : Float</b>
40019	Network Parity Stop	Float	00	12	Write the network port parity/stop bits for MODBUS Protocol.where: 0 = One stop bit and no parity, 1 default.= One stop bit and even parity. 2 = One stop bit and odd parity. 3 = Two stop bits and none parity. Requires a restart to become effective. <b>Length : 4 byte</b> <b>Data Format : Float</b>
40021	Meter ID	Float	00	14	Ranges from 1 to 247, Default ID is 1. <b>Length : 4 byte</b> <b>Data Format : Float</b>
40029	Baud rate	Float	00	1C	Write baud rate for MODBUS Protocol, where: 0 = 2400 baud (default) 1 = 4800 baud. 2 = 9600 baud 5=1200 baud . <b>Length : 4 byte</b> <b>Data Format : Float</b>
40087	Pulse 1 output mode	Float	00	56	Write MODBUS Protocol input parameter for pulse out 1: 0001: Import active energy, 0002: Total active energy ( Imp + exp) 0004: Export active energy (default).

					0005: Import reactive energy 0006: Total reactive energy (Imp+ exp) 0008: Export reactive energy <b>Length : 4 byte</b> <b>Data Format : Float</b>
461457	Reset historical data	Hex	F0	10	00 00: reset demand info <b>Length : 2 byte</b> <b>Data Format : Hex</b>
463745	Time of scroll display	BCD	F9	00	0-30s Default 0: does not display in turns <b>Length : 2 byte</b> <b>Data Format : BCD</b>
463761	Pulse 1 output	Hex	F9	10	0000: 0.001kWh/imp (default) 0001: 0.01kWh/imp 0002: 0.1kWh/imp 0003: 1kWh/imp <b>Length : 2 byte</b> <b>Data Format : HEX</b>
463777	Measurement mode	Hex	F9	20	0001: mode 1 (total = import) 0002: mode 2 (total = import + export ) (default) 0003: mode 3 (total = import - export) <b>Length : 2 byte</b> <b>Data Format : HEX</b>
464513	Serial number	Unsigned int32	FC	00	Serial Number <b>Length : 4 byte</b> <b>Data Format: Unsigned int32</b>
464515	Meter code	Hex	FC	02	Meter code = 0XD3 <b>Length: 2 bytes</b> <b>Data Format: Hex</b> Note: read only
464516	Software version	Hex	FC	03	Software version <b>Length: 2 bytes</b> <b>Data Format: Hex</b> Note: read only