

# SDM120-A/D/DB

Single Phase DIN Rail kWh Meter



## Description

The SDM120 Series is a range of 1 module , single phase energy meters consisting of 3 different types, each with their specific characteristics. They are all of a high accuracy Class 1/B. It can be widely used to measure single phase like residential, utility application. The meter measures active energy (kWh) with a pulse output.

## Technical Data

<b>● Performance criteria</b>	
Operating humidity	≤ 90%, non-condensing
Storage humidity	≤ 95%, non-condensing
Operating temperature	-25°C - +55°C
Storage temperature	-40°C - +70°C
Reference temperature	23°C ± 2°C
Warm up time	5s
International standard	IEC 62053-21/ EN 50470-1/3
Accuracy	Class 1 / Class B
Ingress protection	IP51
Mechanical Environment	M1
Insulating encased meter of protective class	II
<b>● Specifications</b>	
Nominal voltage(Un)	230V
Operational voltage	176-276V
Insulation capabilities	
- AC voltage withstand	4KV for 1 minute
- Impulse voltage withstand	6KV-1.2μS
Basic current (Ib/Iref)	5A
Maximum rated current (Imax)	45A
Starting current	0.4% Ib
Over current withstand	30I <sub>max</sub> for 0.01s
Operational frequency range	50Hz(MID)
	50/60Hz (non-MID)
Internal power consumption	≤ 2W/10VA
Pulse output	1000imp/kWh
Display	SDM120A analog display SDM120D LCD SDM120DB LCD with Backlit
Max. reading of SDM120A	99999.9kWh
Max. reading of SDM120D/DB	99999.9kWh

## Safety Instructions

### ● Information for your own safety

This manual does not contain all of the safety measures for operation of the equipment(module, device), because special operating conditions, and local code requirements or regulations may necessitate further measures. However, it does contain information which must be read for your personal safety and to avoid material damages. This information is highlighted by a warning triangle and is represented as follows, depending on the degree of potential danger.



#### ● Warning

This means that failure to observe the instruction can result in death, serious injury or considerable material damage.



#### ● Caution

This means hazard of electric shock and failure to take the necessary safety precautions will result in death, serious injury or considerable material damage.

### ● Qualified personnel

Operation of the equipment (module, device) described in this manual may only be performed by qualified personnel. Qualified personnel in this manual means person who are authorized to commission, start up, ground and label devices, systems and circuits according to safety and regulatory standards.

### ● Proper handling

The prerequisites for perfect, reliable operation of the product are proper transport, proper storage, installation and assembly, as well as proper operation and maintenance. When operating electrical equipment, certain parts of this equipment automatically carry dangerous voltages. Improper handling can therefore result in serious injuries or material damage.

- ⚡ Use only insulating tools.
- ⚡ Do not connect while circuit is live (hot).
- ⚡ Place the meter only in dry surroundings.
- ⚡ Do not mount the meter in an explosive area or expose the meter to dust, mildew and insects.
- ⚡ Make sure the used wires are suitable for the maximum current of this meter.
- ⚡ Make sure the AC wires are connected correctly before activating the current/voltage to the meter.
- ⚡ Do not connect the meter to a 3 phase - 400VAC - network.
- ⚡ Do not touch the meter connecting clamps directly with your bare hands, with metal, blank wire or other material as you may get an electrical shock.
- ⚡ Make sure the protection cover is placed after installation.
- ⚡ Installation, maintenance and reparation should only be done by qualified personnel.
- ⚡ Never break the seals and open the front cover as this might influence the functionality of the meter, and will avoid any warranty.
- ⚡ Do not drop, or allow physical impact to the meter as there are high precision components inside that may break.

## Dimensions

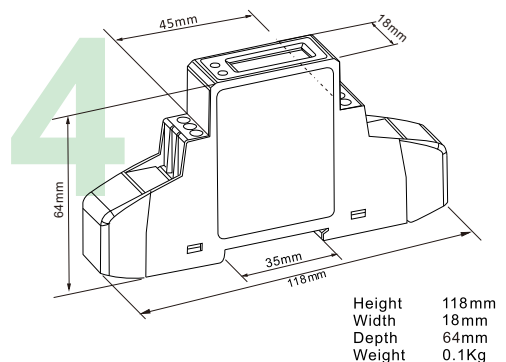

ZHEJIANG EASTRON ELECTRONIC CO., LTD.

Add: No. 52, Dongjin Road, Nanhu, Jiaxing, Zhejiang, China

Tel: +86-573-83698881

Fax: +86-573-83698883

Email: sales@eastrongroup.com

Web: www.eastrongroup.com

# Eastron

## Installation

- ◆ We recommend that the connecting wire which is used to connect the meter to the outside circuit should be sized according to local codes and regulations for the capacity of the circuit breaker or over current device used in the circuit.
- ◆ An external switch or a circuit-breaker should be installed on the inlet wire, which will be used as a disconnection device for the meter. And there it is recommended that the switch or circuit-breaker is near the meter so that it is more convenient for the operator. The switch or circuit-breaker should comply with the specifications of the buildings electrical design and all local regulations.
- ◆ The meter has to be installed against a wall which is fire resistant.
- ◆ The meter has to be installed in a good ventilated and dry place.
- ◆ The meter has to be installed in a protection box when placed in dangerous or dusty environment.
- ◆ The meter can be installed and used after being tested and sealed with a letter press printing.
- ◆ The meter should be installed in an available height so that it is easy to read.

## Operation

### ● Consumption indication

There is a LED on front panel, which flashes when consumption happens. The more quickly LED flashes, the more consumption happens. The constant of the LED is 1000imp/kWh.

### ● Reading the meter

The SDM120A energy meter is equipped with a 5+1 register. Five integers are marked with black color and one decimal is marked with red. The SDM120D series energy meter is equipped with 6 digits LCD display which is used as recording consumption and can't be reset to zero. Before the accumulated reading goes to 10,000kWh, the LCD shows in xxxx.xx (4 integrals+2 decimals). After the reading reaches to 10,000kWh, the LCD shows in xxxxx.x (5 integrals + 1 decimal). The Max. reading is 99999.9kWh.

### ● Pulse output

SDM120 series DIN rail energy meter is equipped with a pulse output which is fully separated from the inside circuit. That generates pulses in proportion to the measured energy. They are test pulse output (pins 6 & 7). Usually, the test pulse output is used as testing accuracy or reading purpose in the close quarters.

The test pulse output is a polarity dependant, passive transistor output requiring an external voltage source for correct operation. For this external voltage source, the voltage (U<sub>i</sub>) should be 5-27V DC, and the maximum input current (I<sub>max</sub>) should be 27mA DC. To connect the impulse output, connect 5-27V DC to connector 7 (anode), and the signal wire (s) to connector 6 (cathode). The meter pulse is indicated on the front panel.

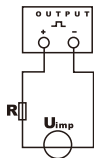

ATTENTION: Pulse output must be fed as shown in the wiring diagram on the left. Scrupulously respect polarities and the connection mode. Opto-coupler with potential-free SPST-NO Contact.

Contact range:5~27VDC  
Max. current input:27mA DC.

## Installation Diagram

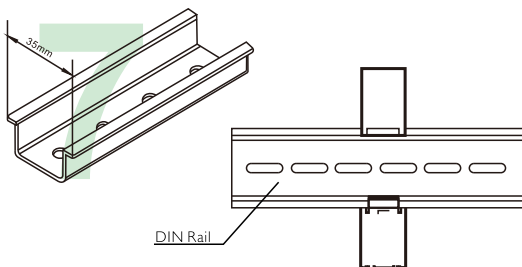

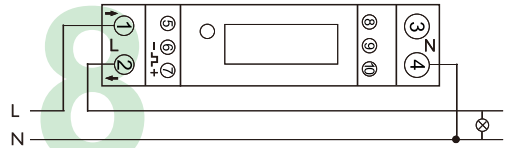

## Wiring ⚡



Terminal 1: L-in  
Terminal 2: L-out  
Terminals 3 & 4: Neutral  
Terminals 6 & 7: Pulse output

### Terminals Capacity and Screw Torque

Terminals		
Pulse	0.5~1.5mm <sup>2</sup>	0.2Nm
Load	2.5~10mm <sup>2</sup>	1.5Nm

## Energy Meter Display

### ● SDM120D/DB

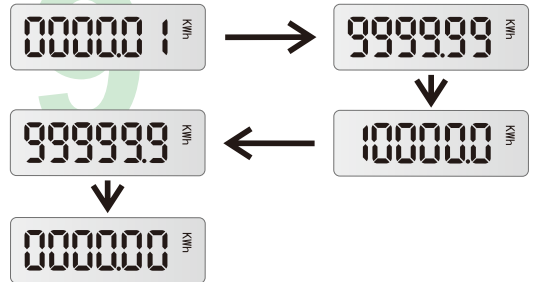

### ● SDM120A

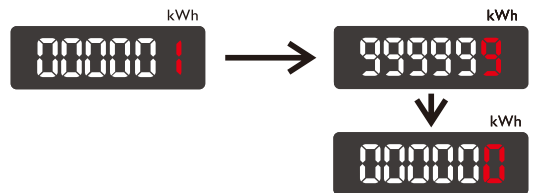

## Conformity Declaration (for MID version meters only)

We Zhejiang Eastron Electronic Co., Ltd.

Declare under our sole responsibility as manufacturer that the single phase active import(kWh) indoor electricity meter SDM120 Series correspond to the production model described in the EU-type examination certificate and to the requirements of the Directive 2014/32/EU type

Examination Certificate NO.0120/SGS0141  
Identification Number of the NB0598

ZHEJIANG EASTRON ELECTRONIC CO., LTD.

Add: No. 52, Dongjin Road, Nanhu, Jiaxing, Zhejiang, China

Tel: +86-573-83698881

Fax: +86-573-83698883

Email: sales@eastrongroup.com

Web: www.eastrongroup.com

**Eastron**

DH-SMS-0318