

SMART X96-5 -F/G/H/I/J

Multi-Function Power Analyzer



- Multi-parameter Measurements
- Up to 63rd THD and IHD
- RS485 Modbus RTU
- Ethernet TCP Gateway
- Multi-tariffs
- Digital Input/Output
- Accuracy Class 0.5s
- Bar Graph for Power Indication
- Backlit LCD Display for Full Viewing Angles
- Push-in Installation and Plug-in Connection

**User Manual
V2.2**

Introduction

The multifunction energy analyzer SMART X96 series is a top new-generation intelligent panel meter, used not only in the electricity transmission and power distribution system, but also in the power consumption measurement and analysis in high voltage intelligent power grid.

This document provides operating, maintenance and installation instructions for the Eastron SMART X96 series. The unit measures and displays the characteristics of 1p2w, 3p4w and 3p3w supplies, including voltage, frequency, current, power and active and reactive energy, imported or exported, Harmonic, Power factor, Max. Demand etc. Energy is measured in terms of kWh, kVAh and kVAh. Maximum demand current can be measured over preset periods of up to 60minutes.

In order to measure energy, the unit requires voltage and current inputs in addition to the supply required to power the product. The requisite current input(s) are obtained via current transformers. The SMART X96 can be configured to work with a wide range of CTs, giving the unit a wide range of operation. Built-in interfaces provides RS485 Modbus RTU and Ethernet TCP/IP communication. Digital input and outputs are provided for external signal counting and external device control. 30 types parameters can be set for alarm.

The unit uses plug-in terminals for easy wiring and push-in mechanism for quick installation.

1. Unit Characteristics

1.1 The Unit can measure and display:

- Line voltage and THD% (total harmonic distortion) of all phases
- 2~63rd voltage IHD% (Individual Harmonic distortion) of all phases
- Line Frequency
- Phase Sequence
- Currents, Current demands and current THD% of all phases
- 2~63rd current IHD% of all phases
- Active power, reactive power, apparent power, maximum power demand and power factor
- Max./ Min.Current and voltage, Max.current demand
- Import / export / total active energy
- Import / export / total reactive energy
- Total active energy of each phase
- Multi Tariff active energy
- DPF (Displacement Power factor, Modbus read only)
- Voltage crest factor (Modbus read only)
- Current K factor (Modbus read only)

1.2 The unit has password-protected set-up screens for:

- **Communication setting:** Modbus address, Baud rate, Parity, Stop bit
- **CT setting:** CT 1 (Primary) , CT2 (Secondary), CT rate
- **PT setting:** PT1 (Primary), PT2 (Secondary) , PT rate
- **Demand setting:** demand method, Demand interval time
- **Time setting:** Backlit time, display scroll time, system RTC, Tariff Time
- **System configuration:** System type, System connect, Change password, Auto display scroll
- **DI setting:** DI filter time ,DI count,
- **DO setting:** Alarm setting, Delay time, HC(high value to close), HO (High value to open), LO(Low value to open), LC(low value to close)
- **Ethernet(TCP/IP) Communication setting:** IP Address, Subnet Master, Gateway, IP port , Mode
- **SOE (sequence of event) Information:** 20 SOE and times
- **Reset:** Energy, Demand, Max.Min value, SOE, DI count, All

1.3 CT and PT

CT1 (primary current): 1~9999A

CT2 (secondary current): 1A or 5A

PT1 (primary voltage): 50V ~ 600,000V

PT2 (secondary voltage): 50 to 600 V AC (L-L)

1.4 RS485 Serial-Modbus RTU

This unit uses a RS485 serial port with Modbus RTU protocol to provide a means of remote monitoring and controlling.

Please check the Part 4.2 for the details of setting.

1.5 Ethernet TCP/IP

This unit equipped with an Ethernet (TCP/IP) communication port for rapid and reliable data transfer. It would be easy to integrate the meter into a network. The meter can also be set as an RS485Modbus to TCP/IP gateway.

1.6 Display

Liquid crystal display with backlit (360° full viewing angles)

4 lines, 4 digits per line to show electrical parameters

5th line, 8 digits to show energy

Bar graph for power indication

Display update time: 1 sec. for all parameters

Display scrolling: automatic or manual (Programmable)





2. Start up screens

	<p>The first screen lights all LED segments and can be used as a display LED check</p>
	<p>The second screen indicates the software version of the unit. (the left picture is just for reference)</p>
	<p>The unit performs a self-test and the screen indicates if the test is passed.</p>

After a short delay, the default measurement screen appears.

3. Buttons and Displays

3.1 Buttons Function

Buttons	Click	Press 2S
	<ul style="list-style-type: none"> ➤ Displays power, voltage, current and energy information of each phase ➤ Exit from the menu 	<ul style="list-style-type: none"> ➤ Automatic Scroll display ON / OFF
	<ul style="list-style-type: none"> ➤ Display Voltage and current information of the selected system type. (3p4w, 3p3w and 1p2w) ➤ Phase sequence ➤ Left side move 	<ul style="list-style-type: none"> ➤ Individual Harmonic Distortion of Voltage up to 63rd
	<ul style="list-style-type: none"> ➤ Display power factor, frequency, Max. Demand. ➤ Max. and Min. of current and voltage ➤ Up page or add value 	<ul style="list-style-type: none"> ➤ Individual Harmonic Distortion of Current up to 63rd
	<ul style="list-style-type: none"> ➤ Display active power, reactive power and apparent power information of the selected system type. ➤ Down page or reduce value 	<ul style="list-style-type: none"> ➤ Running hour ➤ Full Screen checking ➤ Modbus / Ethernet setting information ➤ Tariff Information
	<ul style="list-style-type: none"> ➤ Display total / import / export active or reactive energy information of the selected system type. ➤ Right side move 	<ul style="list-style-type: none"> ➤ Set-up mode entry ➤ Confirmation

3.2 Display Mode Screen Sequence

Click button	3 Phase 4 Wire		3 Phase 3 Wire		1 Phase 2 Wire	
	Screen	Parameters	Screen	Parameters	Screen	Parameters
	1	Phase 1 – Power Voltage Current kWh			1	Phase 1 – Power Voltage Current kWh
	2	Phase 2 – Power Voltage Current kWh				
	3	Phase 3 – Power Voltage Current kWh				
	4	Phase 1 – Power Voltage Current kVArh			2	Phase 1 – Power Voltage Current kVArh
	5	Phase 2 – Power Voltage Current kVArh				
	6	Phase 3 – Power Voltage Current kVArh				
	1	Voltage L1-N Voltage L2-N Voltage L3-N			1	Voltage L1-N
	2	Voltage L1-L2 Voltage L2-L3 Voltage L3-L1	1	Voltage L1-L2 Voltage L2-L3 Voltage L3-L1		
	3	Current L1 Current L2 Current L3 Current Neutral	2	Current L1 Current L2 Current L3	2	Current L1
	4	THD% of Voltage L1 THD% of Voltage L2 THD% of Voltage L3	3	THD% of Voltage L1-2 THD% of Voltage L2-3 THD% of Voltage L3-1	3	THD% of Voltage L1
	5	THD% of Current L1 THD% of Current L2 THD% of Current L3	4	THD% of Current L1 THD% of Current L2 THD% of Current L3	4	THD% of Current L1
	6	Phase Sequence	5	Phase Sequence		

	1	Total Power Factor Frequency	1	Total Power Factor Frequency	1	Total Power Factor Frequency
	2	PF L1 PF L2 PF L3				
	3	Max. DMD of Current L1 Max. DMD of Current L2 Max. DMD of Current L3	2	Max. DMD of Current L1 Max. DMD of Current L2 Max. DMD of Current L3	2	Max. DMD of Current L1
	4	Max. DMD of W Max. DMD of VAr Max. DMD of VA	3	Max. DMD of W Max. DMD of VAr Max. DMD of VA	3	L1 Max. DMD of W L1 Max. DMD of VAr L1 Max. DMD of VA
	5	Max. Voltage L1-N Max. Voltage L2-N Max. Voltage L3-N	4	Max. Voltage L1-L2 Max. Voltage L2-L3 Max. Voltage L3-L1	4.	Max. Voltage L1-N
	6	Min. Voltage L1-N Min. Voltage L2-N Min. Voltage L3-N	5	Min. Voltage L1-L2 Min. Voltage L2-L3 Min. Voltage L3-L1	5.	Min. Voltage L1-N
	7	Max. Current L1 Max. Current L2 Max. Current L3 Max.Current Neutral	6	Max. Current L1 Max. Current L2 Max. Current L3	6	Max. Current L1
	8	Min. Current L1 Min. Current L2 Min. Current L3 Min.Current Neutral	7	Min. Current L1 Min. Current L2 Min. Current L3	7	Min. Current L1
	9	Max. W Max. VAr Max. VA	8	Max. W Max. VAr Max. VA	8	Max. W Max. VAr Max. VA
	10	Min. W Min. VAr Min. VA	9	Min. W Min. VAr Min. VA	9	Min. W Min. VAr Min. VA
	1	Active Power L1 Active Power L2 Active Power L3				
	2	Reactive Power L1 Reactive Power L2 Reactive Power L3				
	3	Apparent Power L1 Apparent Power L2 Apparent Power L3				

	4	Total Active Power Total Reactive Power Total Apparent Power	1	Total Active Power Total Reactive Power Total Apparent Power	1	L1 Active Power L1 Reactive Power L1 Apparent Power
	1	Total kWh	1	Total kWh	1	Total kWh
	2	Total kVArh	2	Total kVArh	2	Total kVArh
	3	Import kWh	3	Import kWh	3	Import kWh
	4	Export kWh	4	Export kWh	4	Export kWh
	5	Import kVArh	5	Import kVArh	5	Import kVArh
	6	Export kVArh	6	Export kVArh	6	Export kVArh
	7	T1 kWh	7	T1 kWh	7	T1 kWh
	8	T2 kWh	8	T2 kWh	8	T2 kWh
	9	T3 kWh	9	T3 kWh	9	T3 kWh
	10	T4 kWh	10	T4 kWh	10	T4 kWh
	11	Date	11	Date	11	Date
	12	Time	12	Time	12	Time

3.3 Individual Harmonic Distortion:

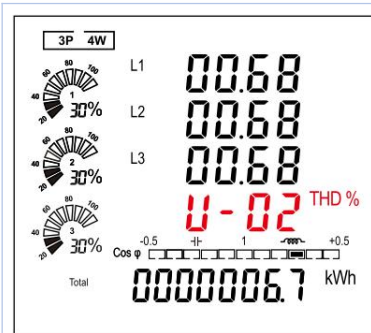

Press the button for 2 seconds to check Harmonic distortion of Voltage

2~63rd Harmonic Distortion of Voltage

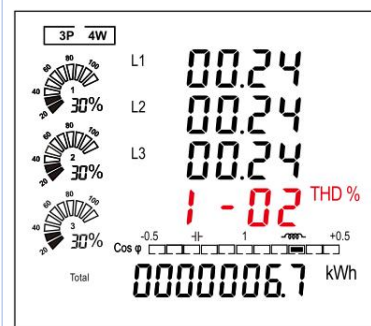



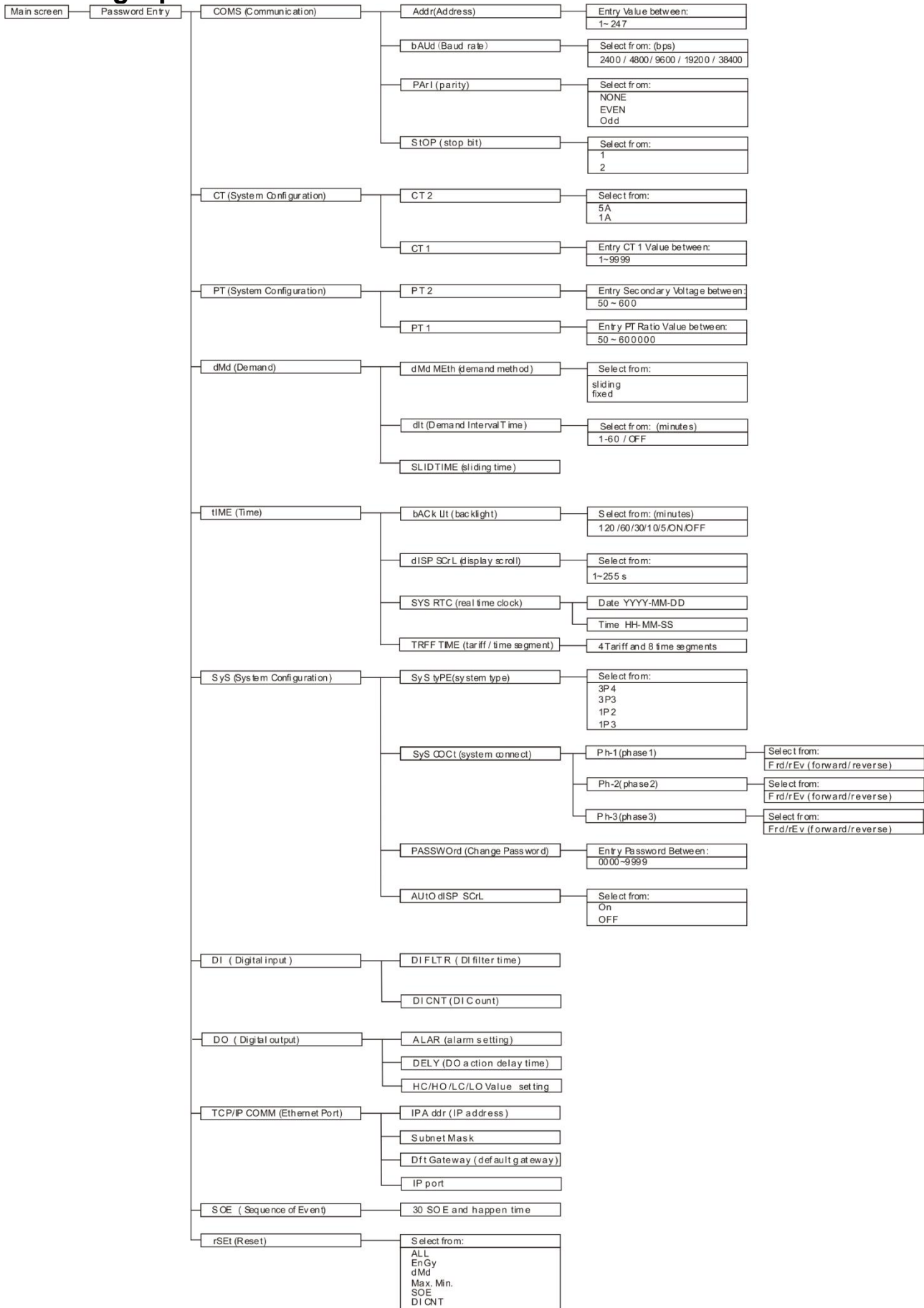

Press the button for 2 seconds to check Harmonic distortion of Current

2~63rd Harmonic Distortion of Current

4. Setting-Up







4.1 Password Entry

	<p>Setting-up mode is password protected, so you must enter the correct password.</p> <p>Default password: 1000</p> <p>By firmly press the button  for 2 seconds, the password screen appears. Use  and ,  to set the password. If an incorrect password is entered, the display shows ERR.</p>
--	--

4.2 Communication

	<p>Communication set up menu:</p> <p>The RS485 port can be used for communications using Modbus RTU protocol. Parameters such as Address, Baud rate, Parity, Stop bit can be selected.</p> <p>Long press  to enter the communication menu, which including Address option.</p>
--	--

4.2.1 Address



	<p>An RS485 network can accommodate up to 247 different devices, each identified by an address.</p> <p>Modbus address range 001~247</p> <p>Default 001</p> <p>Long press  to enter the selection routine, the address setting will flash. Use  and ,  to set the address with the range 001~247. And long press  for confirmation.</p>
--	--

4.2.2 Baud rate





	<p>Baud rate options: 2400 4800 9600 19200 38400 (bps). Default: 9600bps</p> <p>From the Communication menu, Use and to select the Baud rate options. Long press to enter the selection routine. The Baud Rate setting will flash. Use and to choose Baud Rate.</p>
	<p>Example shows: SET Baud rate: 19200 (bps)</p> <p>And long press for confirmation.</p>



4.2.3 Parity

	<p>Parity Options: NONE, EVEN, ODD. Default Parity : NONE</p> <p>From the Communication menu, Use and to select the Parity options. Long press to enter the selection routine. The Parity setting will flash. Use and to choose Parity.</p>
	<p>Example shows: Set Parity: EVEN</p> <p>*Note that Parity can only be changed to EVEN when the Stop Bits is set to 1.</p> <p>And long press for confirmation. Press to return the communication set up menu.</p>



	<p>Example shows: Set Parity: Odd</p> <p>*Note that Parity can only be changed to Odd when the Stop Bits is set to 1.</p> <p>And long press  for confirmation. Press  to return the communication set up menu.</p>
--	--

4.2.4 Stop bit

	<p>Stop Bit options: 1 or 2. Default Stop Bit : 1 Note that if parity is set to ODD or EVEN, Stop Bits will be set to 1 and cannot be changed.</p> <p>From the Communication menu, Use  and  to select the Stop Bit options. Long press  to enter the Stop Bit routine. The Stop Bit setting will flash. Use  and  to choose Stop Bit.</p>
--	--

	<p>Example shows Set Stop bit 2</p> <p>And long press  for confirmation. Press  to return the Communication set up menu.</p>
--	--

4.3 CT

	<p>CT set up menu:</p> <p>From the main Set-up menu, Use  and  to select the CT option.</p>
--	--

4.3.1 CT2

	<p>Set secondary current input the meter Options: 5A or 1A Default CT2: 5A</p> <p>Long press to enter the CT2 routine. Press for 2s, the CT2 setting will flash. Use and to choose CT2 with 5A or 1A.</p>
	<p>Example shows : Set CT2 1A</p> <p>And long press for confirmation.</p>

4.3.2 CT1

	<p>Set primary current input the meter Options: 1~9999 Default CT1: 5A</p> <p>Use and to enter the CT1 routine. Press for 2s, the CT1 setting will flash. Use and to choose CT1 with 1~9999.</p>
	<p>Example shows : Set CT1 100A</p> <p>And long press for confirmation. Press to return the CT set up menu.</p>

4.4 PT

	<p>PT set up menu: The PT option sets the primary voltage and secondary voltage of the voltage transformer (PT) that give into the meter.</p> <p>For example: if the PT connect to the meter is 10000/100V , Primary voltage is 10000V, secondary voltage is 100V.</p> <p>Long press to enter the PT2 routine. Press for 2s, the PT2 setting will flash. Use and , to choose PT2 with 50~600.</p>
--	--

4.4.1 PT2

	<p>Set secondary voltage input the meter Range: 50V ~ 600V Default: 230V</p> <p>And long press for confirmation.</p>
--	---

4.4.2 PT1

	<p>Set primary voltage input the meter Range: 50V ~ 600000V Default: 230V</p> <p>Then press to enter the PT1 routine. press for 2s, the PT1 setting will flash. Use and , to select PT1. And long press for confirmation. Press to return the PT set up menu.</p>
--	--

4.5 Demand

	<p>This sets the period in minutes over which the current and power readings are integrated for maximum demand measurement. The options are: OFF, 5, 8, 10, 15,30, 60 minutes.</p> <p>From the Set-up menu, Use and to select the Demand option.</p>
--	--

The unit provides block interval demand calculation. In this method, you select a ‘block’ of time that power meter uses for the demand calculation. You choose how the power meter handles that block of time (interval). Two different modes are optional.

Slide Block: Select a demand interval time (DIT) from 1 to 60 minutes (in 1 minute increments). Set the calculation update time from 1 to 59minutes. The power meter displays the demand value for the last completed interval.

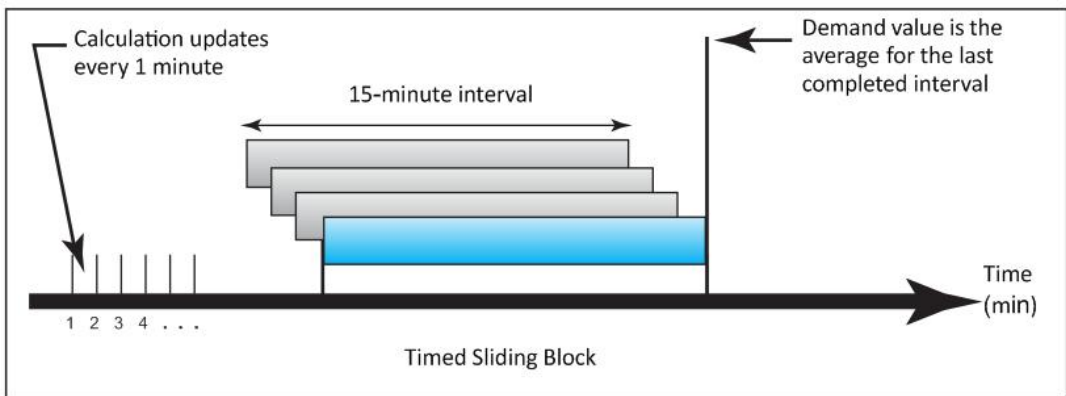

Fixed Block: Select an interval from 1 to 60 minutes (in 1 minute increments). The power meter calculates and updates the demand at the end of each interval.

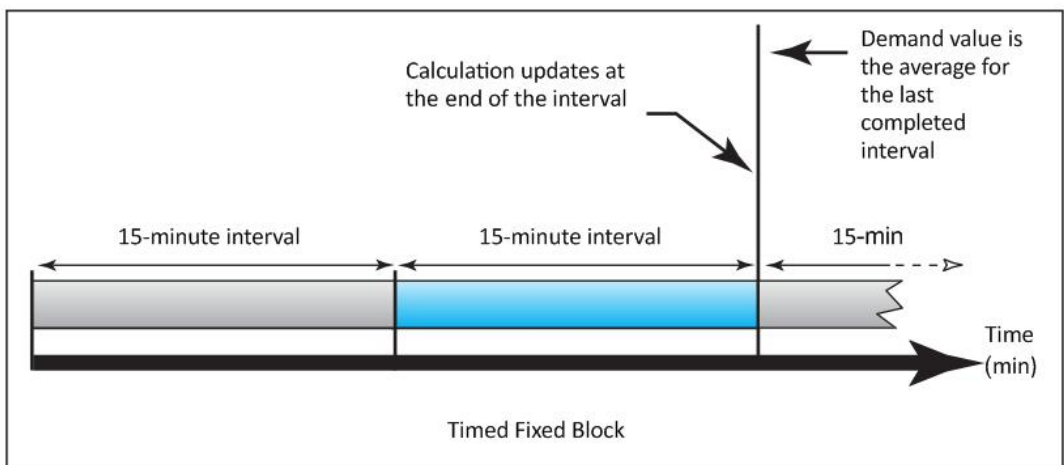

4.5.1 Demand method

	<p>The screen shows the Demand calculation method: Slid Options: Fix and Slid</p> <p>Use and to enter Demand calculation method.</p>
	<p>Long press to enter the routine. The setting will flash. Use and to choose Options. And long press for confirmation.</p>

4.5.2 Demand interval time/ Block time (DIT)

	<p>The screen will show the currently selected integration time. Default is 60 minutes. range from 1 to 60. Off means function closed.</p> <p>Then press to enter the DIT routine. Press for 2s, the setting will flash. Use and to choose Options. And long press for confirmation.</p>
--	---

4.5.3 Sliding time

	<p>The screen will show the Sliding time for the sliding mode.</p> <p>The sliding time shall be set not bigger than the DIT.</p>
--	--

4.6 Time

	<p>Time set up menu:</p> <p>This option sets the backlight lasting time and display scroll time.</p> <p>From the Set-up menu, Use and to select the Time option.</p>
--	--

4.6.1 Backlight time

	<p>The meter provides a function to set the backlit lasting time. Options: ON/OFF/5/10/30/60/120 minutes. Default: 60 If it is seated as 5, the backlit will be off in 5 minutes. Note: if it is set as ON, the backlit will always be on.</p> <p>Long press to enter the Backlit time routine. Press for 2s, the setting will flash. Use and to choose Options. And long press for confirmation.</p>
--	--

4.6.2 Display scroll time

	<p>The meter provides a function to set the Display scroll time. Options: 1~255s Default: 5 If it is seated as 5, the display will scroll every 5s.</p> <p>Use and to select Display scroll time option. Press for 2s, the setting will flash. Use and to choose Options. And Long press for confirmation. Press to return to the time set up menu.</p>
--	--

4.6.3 System RTC

	<p>This option is to set the real time clock for the meter.</p> <p>Use and to enter the real time clock option.</p>
	<p>Set the date of RTC. Left picture shows 2017-Otc-1st The format is YYYY-MM-DD</p> <p>press for 2s, the date setting will flash. Use and , to set the year, month and date. Long press for confirmation.</p>
	<p>Set the time of RTC Left picture shows 16:20:58 The format is HH-MM-SS</p> <p>Use to enter the time setting option. Press for 2s, the time setting will flash, use and , to set the year, month and date. Long press for confirmation. Press to return to the time set up menu.</p>

4.6.4 Tariff Time

	<p>This option is to set the time segments with different tariffs.</p> <p>Use and to enter the time segments and tariffs setting.</p>
--	---

	<p>Set the time segments and corresponding tariffs</p> <p>Left pictures shows:</p> <p>Time</p> <p>01 – time segment number , range from 01 to 08</p> <p>06:00 – starting time of this time segment, format : HH-MM</p> <p>FEE1 – Tariff 1 , range 1~4.</p> <p>Use and to choose the time segment number, press the for 2s, user can set the starting time of this time segment and tariff information.</p>
--	---

4.7 System

	<p>System set up menu:</p> <p>The Unit has a default setting of 3 phase 4 wire (3p4w). Use this section to set the type of electrical system.</p> <p>Options: 3P34,3P3W,1P2W</p> <p>From the Set-up menu, Use and to select the System option</p>
--	--

4.7.1 System type

	<p>The screen shows the currently selected power supply is three phase four wire</p> <p>Long press to enter the System type routine. Press for 2s, the setting will flash. Use and to choose Options. And Long press for confirmation.</p>
	<p>Example shows:</p> <p>The screen shows the currently selected power supply is three phase three wire</p>

	<p>Example shows: The screen shows the currently selected power supply is single phase two wire</p>
--	---

4.7.2 System connect

	<p>This unit provides a function with Reverse connected current inputs correction setting.</p> <p>Use and to select the correction option.</p>
	<p>Options: Frd (forward) and rEv (reverse) The default is FRD (forward)</p> <p>Long press to enter the Phase 1 correction. Press for 2s, the setting will flash. Use and to choose Options. And long press for confirmation.</p>
	<p>Press enter Phase 2 correction. Press for 2s, the setting will flash. Use and to choose Options. And long press for confirmation.</p>
	<p>Press enter Phase 3 correction. Press for 2s, the setting will flash. Use and to choose Options. And long press for confirmation. Press to return the System set up menu.</p>

4.7.3 Change password



	<p>This unit provides a function with password setting. Default: 1000 Options:0000~99999</p> <p>Use and to select the change password option.</p>
	<p>Press for 2s, the setting will flash. Use and , to choose Options. And long press for confirmation.</p>



4.7.4 Automatic display scroll

	<p>This unit provides a function with automatic display scroll setting. Options: on and off There are two ways:</p> <p>① Use and to select the automatic display scroll option.</p> <p>Press for 2s, the setting will flash. Use and to choose options "On" or "Off". And long press for confirmation.</p>
	<p>② Escape the Setting menu. Long press for 2 secs. For example, the screen shows the currently selected Automatic Scroll display ON.</p>

	<p>Long press  for 2 secs, then the screen shows the currently selected Automatic Scroll display OFF.</p>
--	--





4.8 Digital Input (DI)

	<p>This option is to set Digital input parameter. By pressing , getting to the sub-menu</p>
	<p>This is to set filtering time for a digital input signal. Left picture shows 100mS</p>
	<p>This screen is to check the counting number of each digital inputs. By pressing the , the user can see counting numbers.</p>

	<p>Left picture shows Digital input 1, counting number is 8.</p> <p>By pressing  and  , the user can see counting number of different digital inputs.</p>
--	---

4.9 Digital Outputs (DO)



4.9.1 General

	<p>This option is to set Digital Output parameter and checking the status.</p> <p>By pressing the  , getting to the sub-menu</p>
	<p>This screen to choose the Digital output number which you want to check. Left picture shows DO-1.</p> <p>By pressing the  , the user can setting the parameter and checking the status of DO-1.</p> <p>By click the  and  , the user can choose different Digital Output.</p>
	<p>This screen is to set the alarm information link to DO-1 For details , please refer to part 4.9.2</p>

	<p>This screen is to set the digital output Type for DO-1 Left picture shows LEVE</p> <p>LEVE = Level PULS = Pulse</p>
	<p>This screen is to control the status of DO-1 relay Left picture shows the status is Open</p>

4.9.2 Alarm setting of DO

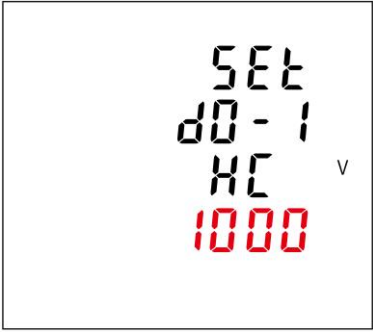
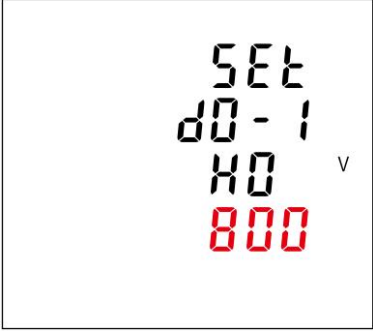
	<p>This option is to set alarm for DO.</p>
	<p>The Alarm can be linked to the parameters below: U1, U2, U3, Unav (L-N) U12, U23, U31, Uuav (L-L) I1, I2, I3, Iav, In P1, P2, P3, P-total Q1, Q2, Q3, Q-total S1, S2, S3, S-total PF1, PF2, PF3, PF-total F (frequency) Null means the Alarm is not linked to any parameter.</p>
	<p>This option is set the DO action delay time. The unit is mS. Left picture shows 200mS.</p>

 <p>The LCD display shows the following text: 'SET' at the top, 'd0-1' below it, 'HC' below that, and '1000' in red at the bottom. A small 'V' is visible to the right of the 'HC' text.</p>	<p>This option is to set the high value for DO-1 close. Left picture shows HC (High value to Close) 1000V, that means when the U1 reaches to 1000V, the DO-1 will close.</p>
 <p>The LCD display shows the following text: 'SET' at the top, 'd0-1' below it, 'HO' below that, and '800' in red at the bottom. A small 'V' is visible to the right of the 'HO' text.</p>	<p>This option is to set the high value for DO-1 open. Left picture shows HO (High value to Open) 800V, that means when the U1 drops to 800V, the DO-1 will open.</p>
 <p>The LCD display shows the following text: 'SET' at the top, 'd0-1' below it, 'LC' below that, and '100' in red at the bottom. A small 'V' is visible to the right of the 'LC' text.</p>	<p>This option is to set the Low value for DO-1 Close. Left picture shows LC (Low value to Close) 100V, that means when the U1 drops to 100V, the DO-1 will open.</p>
 <p>The LCD display shows the following text: 'SET' at the top, 'd0-1' below it, 'LO' below that, and '170' in red at the bottom. A small 'V' is visible to the right of the 'LO' text.</p>	<p>This option is to set the Low value for DO-1 open. Left picture shows LO (Low value to Open) 170V, that means when the U1 returns to 170V, the DO-1 will open.</p>

4.10 Ethernet Communication

	<p>This menu is to set the parameter for Ethernet communication.</p> <p>By pressing the button , the user can get into sub-menu.</p>
	<p>This option is to set the IP address.</p>
	<p>This option is to set Subnet Mask</p>
	<p>This option is to set the default Gateway</p>
	<p>This option is to set the IP port</p>



	<p>This option is to set the meter Ethernet mode SLAV = slave MAST = Master</p> <p>When it is set to be Master, it can works as a RS485-TCP/IP convertor.</p>
--	---

4.11 SOE information

The meter provides SOE record. 30 events and their happen time will be saved in the SOE. When the following events happen, it would be recorded



1. Meter power off
2. Meter power on
3. CT2 changed
4. CT1 changed
5. PT2 changed
6. PT1 changed
7. Energy reset
8. Demand reset
9. Alarm happens

	<p>This menu is to check sequence of events (SOE). The meter can record 30 events.</p> <p>By pressing the button , the user can get into sub-menu.</p>
--	--

	<p>Left picture shows No.1 event</p> <p>By click the  and , the user can check other events.</p>
--	--

	<p>By pressing the button , the user can find the date and time when the event happened.</p>
--	---

4.12 Reset

	<p>This unit provides a function with reset for different information.</p> <p>By pressing the button , the user can get into sub-menu.</p> <p>Use  and  to select the Reset option.</p>
	<p>This option is to reset Energy information. It would reset active, reactive, apparent, import, export energy information.</p>
	<p>This option is to reset the demand information. It would reset current and power demand information.</p>
	<p>This option it to reset tsyshe Max. and Min. information</p>
	<p>This option is to reset the SOE information.</p>

	<p>This option is to reset Digital input counting.</p>
	<p>This option is to reset all information.</p>

5. Specifications

Table 1

Electrical characteristics			
Type of measurement		RMS including harmonics on three phase AC system (3P, 3P+N) 128 samples per cycle	
Measurement accuracy	Power	IEC 61557-12 Class 0.5	
	Active Energy	IEC 62053-22 Class 0.5S, IEC 61557-12 Class 0.5	
	Reactive Energy	± 1%	
	Frequency	± 0.2%	
	Current	± 0.5%	
	Voltage	± 0.5%	
	Power Factor	± 0.01	
Harmonic Distortion		2	
Data Update Rate		1 second nominal	
Input-Voltage	VT Primary	50 ~ 600000 Vac	
	Un	230 V L-N	
	Measured Voltage with Over-range and Crest Factor	50 to 600 Vac L-L 50 to 345 Vac L-N	
	Permanent Overload	600 V L-L 345 V L-N	
	Impedance	1M Ω	
	Frequency Range	45~65Hz	
Input- Current	CT Ratings	Primary	1~9999A
		Secondary	1A / 5A
	Measured current with Over-range and Crest Factor	5mA~6A	
	Withstand	Continuous 8A 120A for 0.5Seconds	
	Impedance	< 1 m Ω	
	Frequency Range	45~65Hz	
	Burden	<0.036VA at 6A	
Auxiliary Power Supply	Operating Range	85~275V AC / 120~380V DC	
	Power Consumption	< 7VA/3.5W.	
	Frequency	45 to 65 Hz	
Digital output	Number/Type	2 - electromagnetic relay	
	Output Frequency	1 Hz maximum	
	Switching Current	250 Vac at 3.0 Amps, 100k cycles,	
	Isolation	2.5 KVac for 1min	
Digital Input	Number	4	
	Input Resistance	10 kΩ	
	Maximum Frequency	1kHz	
	Response Time	10 milliseconds	
	Isolation	2.5 KVac for 1min	
Mechanical Characteristics			
Weight		250g	
IP Degree of Protection (IEC 60529)		IP51 front display	
Dimensions (WxHxD)		96x96x70.3	
Mounting Position		Vertical	
Panel Thickness		1~5mm	

Material of meter case	Self-extinguishing UL 94 V-0
Mechanical environment	M1
Environmental Characteristics	
Operating Temperature	-25 to 55°C
Storage Temperature	-40 to 70°C
Humidity Rating	<95% RH at 50 °C (non-condensing)
Pollution Degree	2
Altitude	2000m
Vibration	10Hz to 50Hz, IEC 60068-2-6
Electromagnetic Compatibility	
Electrostatic Discharge	IEC 61000-4-2
Immunity to Radiated Fields	IEC 61000-4-3
Immunity to Fast Transients	IEC 61000-4-4
Immunity to Impulse Waves	IEC 61000-4-5
Conducted Immunity	IEC 61000-4-6
Immunity to Magnetic Fields	IEC 61000-4-8
Immunity to Voltage Dips	IEC 61000-4-11
Radiated Emissions	EN55011 Class A
Conducted Emissions	EN55011 Class A
Harmonics	IEC 61000-3-2
Safety	
Measurement Category	Per IEC61010-1 CAT III
Current Inputs	Require external Current Transformer for Insulation
Over voltage Category	CAT III
Dielectric Withstand	As per IEC 61010-1 Double Insulated front panel display
Protective Class	II
Communications	
Interface standard and protocol	RS485 and MODBUS RTU
Communication address	1~247
Transmission mode	Half duplex
Data type	Floating point
Transmission distance	1000m Maximum
Transmission speed	2400bps~38400bps
Parity	None (default), Odd, Even
Stop bits	1 or 2
Response time	<100 mS

Table 2

Features	Models				
	X96-5F	X96-5G	X96-5H	X96-5I	X96-5J
Instantaneous Measurements					
Current	•	•	•	•	•
Voltage L-N	•	•	•	•	•
L-L	•	•	•	•	•
Frequency	•	•	•	•	•
Active power	•	•	•	•	•
Reactive power	•	•	•	•	•
Apparent power	•	•	•	•	•
Power factor	•	•	•	•	•
Energy Values					
Active energy	•	•	•	•	•
Reactive energy	•	•	•	•	•
Apparent energy	•	•	•	•	•
Demand Values					
Current	•	•	•	•	•
Active, reactive, apparent power	•	•	•	•	•
Maximum Demand Values					
Maximum current	•	•	•	•	•
Maximum active power	•	•	•	•	•
Maximum reactive power	•	•	•	•	•
Maximum apparent power	•	•	•	•	•
Min. and Max. Value					
Active power per phase and total	•	•	•	•	•
Reactive power per phase and total	•	•	•	•	•
Apparent power per phase and total	•	•	•	•	•
PF per phase and total	•	•	•	•	•
Current per phase and average	•	•	•	•	•
THDi per phase	•	•	•	•	•
THDu L-L and L-N	•	•	•	•	•
Power-Quality Values					
Total harmonic distortion	•	•	•	•	•
Individual Harmonic distortion	63th	63th	63th	63th	63th
Multi Tariffs	*	*	*	*	*
Running Hour	•	•	•	•	•
Real Time Clock	•	•	•	•	•
Network					
Single phase 2 wire	•	•	•	•	•
Two phase 3 wire	•	•	•	•	•
Three phase 3 wire	•	•	•	•	•
Three phase 4 wire	•	•	•	•	•
CT programmable	•	•	•	•	•
PT programmable	•	•	•	•	•
Inputs and Outputs					

Digital Inputs	—	4	—	4	4
Digital Outputs	—	2	—	2	2
Alarms	—	30	—	30	30
Communications					
RS485	●	●	●	●	●
M-Bus	*	*	*	*	*
Lora	*	*	*	*	*
Ethernet	—	—	●	●	●
Ethernet Gateway	—	—	—	—	●
Accuracy					
Active energy	Cl. 0.5s	Cl. 0.5s	Cl. 0.5s	Cl. 0.5s	Cl. 0.5s
Reactive energy	1%	1%	1%	1%	1%
Current	0.5%	0.5%	0.5%	0.5%	0.5%
Voltage	0.5%	0.5%	0.5%	0.5%	0.5%
Power	0.5%	0.5%	0.5%	0.5%	0.5%
THD and IHD	2%	2%	2%	2%	2%
Hz	0.2%	0.2%	0.2%	0.2%	0.2%
Number of measurement points per circle	128	128	128	128	128
Auxiliary power supply	●	●	●	●	●

Note: ● = included
 * = optional
 — = excluded

6. Maintenance

In normal use, little maintenance is needed. As appropriate for service conditions, isolate electrical power, inspect the unit and remove any dust or other foreign material present. Periodically check all connections for freedom from corrosion and screw tightness, particularly if vibration is present.

The front of the case should be wiped with a dry cloth only. Use minimal pressure, especially over the viewing window area. If necessary wipe the rear case with a dry cloth. If a cleaning agent is necessary, isopropyl alcohol is the only recommended agent and should be used sparingly. Water should not be used. If the rear case exterior or terminals should be contaminated accidentally with water, the unit must be thoroughly dried before further use. Should it be suspected that water might have entered the unit, factory inspection and refurbishment is recommended.

In the unlikely event of a repair being necessary, it is recommended that the unit be returned to the factory or nearest Eastron distributor.

Battery Install/ Replacement

The meter supports multi tariffs and RTC. A 3V DC battery need to be installed as backup power supply.

When the battery voltage is lower than 2.4V DC, the meter LCD will shows warning symbol . The user needs to replace the battery with a new one.



Battery model: CR2032

When you install/replace the battery, make sure the meter's voltage input must be disconnected.



7 Installation

The unit may be mounted in a panel of any thickness up to a maximum of 3 mm. Leave enough space behind the instrument to allow for bends in the connection cables. The unit is intended for use in a reasonably stable ambient temperature within the range -25°C to +55°C. Do not mount the unit where there is excessive vibration or in excessive direct sunlight.

7.1 Safety

The unit is designed in accordance with IEC 61010-1:2017 – Permanently connected use, Normal condition. Installation category III, pollution degree 2, basic insulation for rated voltage.

7.2 EMC Installation Requirements

Whilst this unit complies with all relevant EU EMC (electro-magnetic compatibility) regulations, any additional precautions necessary to provide proper operation of this and adjacent equipment will be installation dependent and so the following can only be general guidance:

Avoid routing wiring to this unit alongside cables and products that are, or could be, a source of interference.

The auxiliary supply to the unit should not be subject to excessive interference. In some cases, a supply line filter may be required.

To protect the product against incorrect operation or permanent damage, surge transients must be controlled. It is good EMC practice to suppress transients and surges at the source. The unit has been designed to automatically recover from typical transients; however in extreme circumstances it may be necessary to temporarily disconnect the auxiliary supply for a period of greater than 10 seconds to restore correct operation.

Screened communication leads are recommended and may be required. These and other connecting leads may require the fitting of RF suppression components, such as ferrite absorbers, line filters etc., if RF fields cause problems.

It is good practice to install sensitive electronic instruments that are performing critical functions in EMC enclosures that protect against electrical interference causing a disturbance in function.

Warning



- **During normal operation, voltages hazardous to life may be present at some of the terminals of this unit. Installation and servicing should be performed only by qualified, properly trained personnel abiding by local regulations. Ensure all supplies are de-energized before attempting connection or other procedures.**
- **Terminals should not be user accessible after installation and external installation provisions must be sufficient to prevent hazards under fault conditions.**
- **This unit is not intended to function as part of a system providing the sole means of fault protection - good engineering practice dictates that any critical function be protected by at least two independent and diverse means.**
- **The unit does not have internal fuses therefore external fuses must be used for protection and safety under fault conditions.**
- **Never open-circuit the secondary winding of an energized current transformer.**
- **This product should only be operated with CT secondary connections Earthed.**

- If this equipment is used in a manner not specified by the manufacturer, protection provided by the equipment may be impaired.

Auxiliary circuits (communication & relay outputs) are separated from metering inputs and 85-275V auxiliary circuits by at least basic insulation. Such auxiliary circuit terminals are only suitable for connection to equipment which has no user accessible live parts. The insulation for such auxiliary circuits must be rated for the highest voltage connected to the instrument and suitable for single fault condition. The connection at the remote end of such auxiliary circuits should not be accessible in normal use. Depending on application, equipment connected to auxiliary circuits may vary widely.

7.3 Dimensions

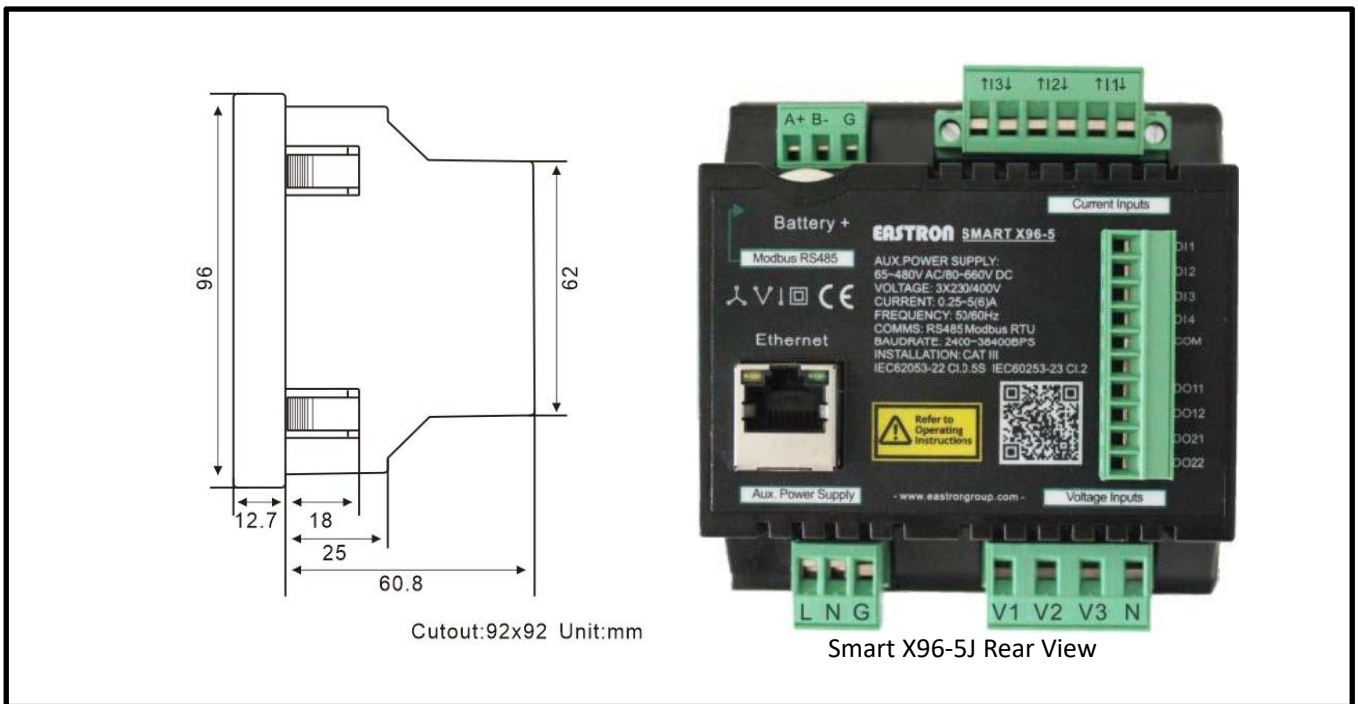

Smart X96-5F



Smart X96-5G



Smart X96-5H



Smart X96-5 I/J

7.4 Mounting

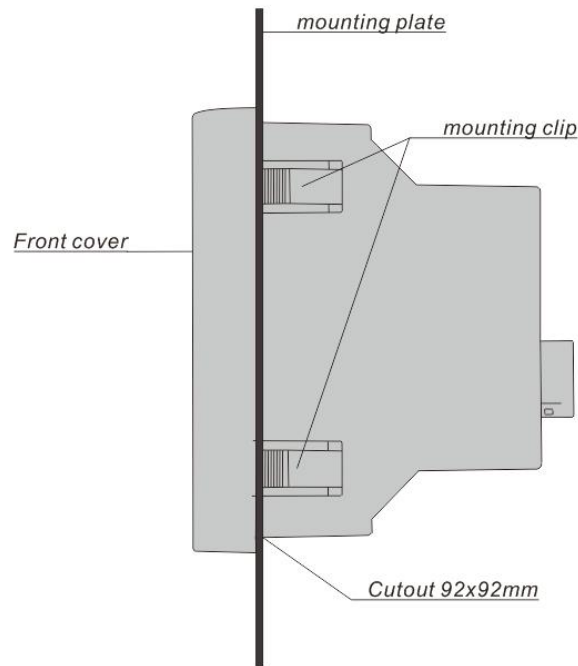

7.5 Wiring Diagram

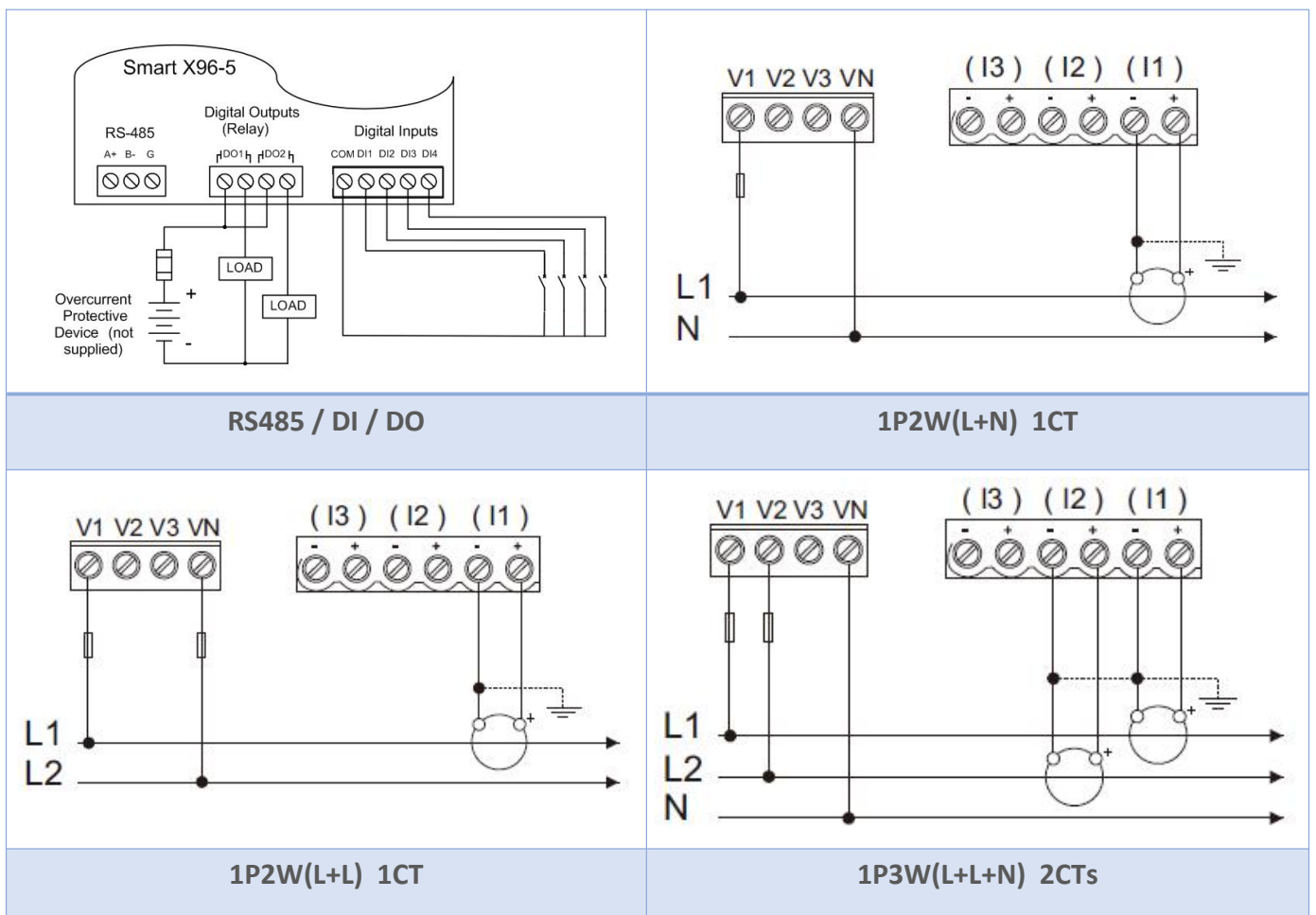

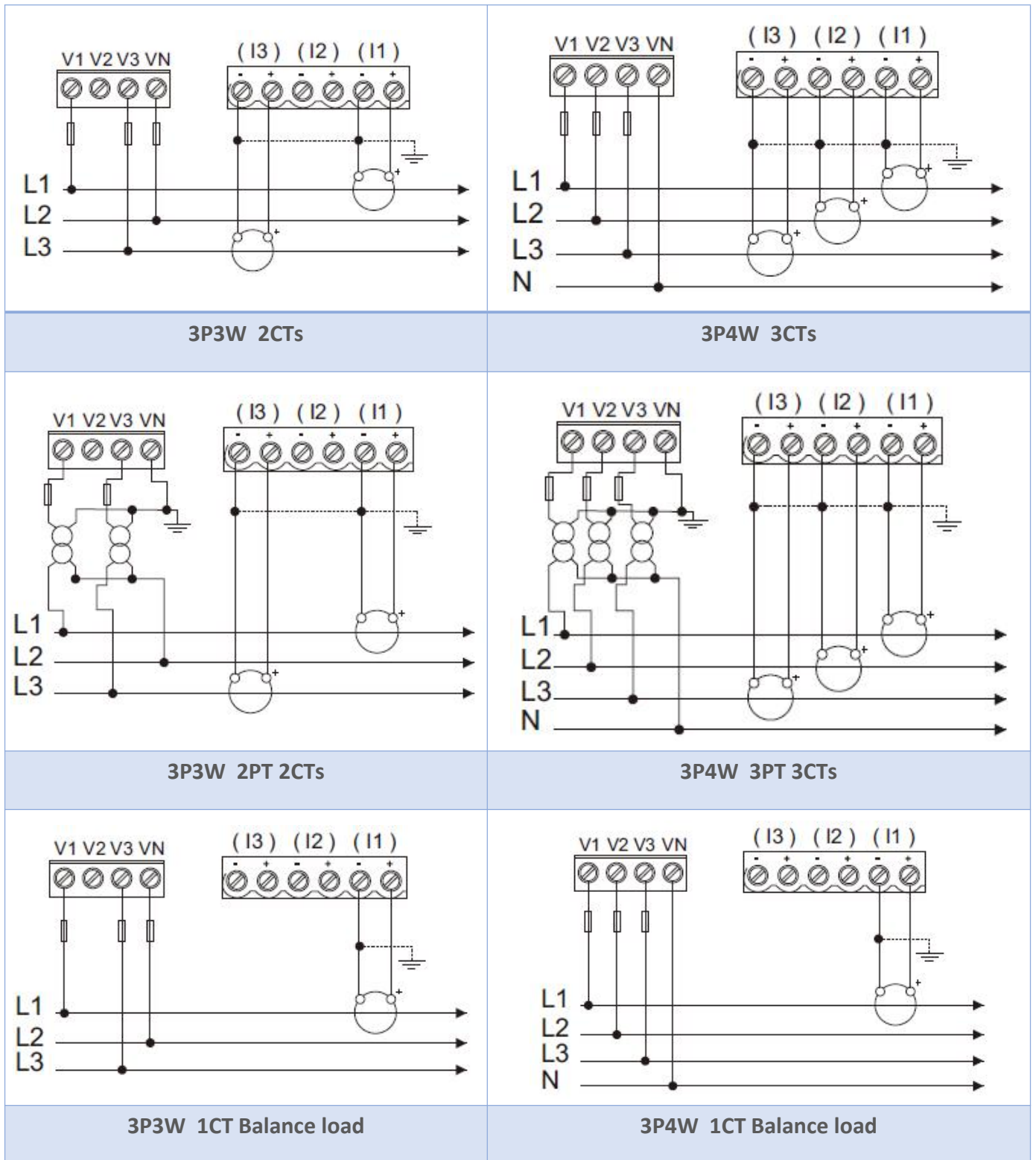

IF you have any question, please feel free to contact our sales team.

Zhejiang Eastron Electronic Co., Ltd.

No.52, Dongjin Rd. Nanhu, Jiaxing, Zhejiang, 314000, China

Tel: +86-573-83698881

Email: sales@eastrongroup.com

www.eastrongroup.com